

Task 31: Fuels and energy carriers for transport

Impact of different drivetrain options, fuels and vehicle use on GHG emissions of cars

Using a tool to determine and compare GHG life cycle impact

Final report



Authors of report

Bert Witkamp, AVERE (Belgium), Operating Agent
René van Gijlswijk, TNO (The Netherlands)
Duncan Kushnir, Chalmers University (Sweden)

Task 31 participating countries: Denmark, Sweden, The Netherlands

Credits: The authors want to thank Dr. Maarten Messagie, VUB Brussels for his support in several meetings and input in the LCA related topics.

1. Summary

The objective of Task 31 of the IEA Hybrid and Electric Vehicle Technology Collaboration Program is to provide stakeholders with credible LCA based information related to cars. This information enables users to determine the impacts on greenhouse gas emissions of different vehicle configurations and use profiles and fuels. The initial set up was to provide a set of data on cars illustrating these impacts. Although this would provide the required comparisons, these would be one time analyses and almost by definition differ from published results. To realize the flexibility needed to analyse and compare for example GHG life cycle data published from different sources, a model has been made allowing the user to define and configure cars as needed. The objective of the model developed is not to predict the future but to investigate the impacts of possible future pathways and thus enable policymakers to make fact based decisions.

Using an easy to use input panel as shown in the figure below, the user defines the car to be analysed using pre-set choices (for example for the choice of drivetrain or car class) or free value fields (for example for vehicle weight or the battery capacity). The model uses peer reviewed and open LCA data as well as data published in EU Framework publications.

Parameter	Unit	Value	
Vehicle Life	km	150000	
Vehicle Class/Chassis Composition		Compact	3
Vehicle Drivetrain Type		BEV	7
Electricity Mix (Use)		EU 28 mix	1
Electricity Mix (Battery Production)		EU 28 mix	1
Electricity Mix (Chassis Production)		EU 28 mix	1
Battery Chemistry		LFP	2
Battery Capacity	KWh	18,7	<input type="checkbox"/> Use Ellingson 2014 for manuf. (high outlier)
Battery Mass	kg	233	<input type="checkbox"/> Entry overrides mass instead of recal. kWh
Battery Cell Recycling		None	1
Vehicle Mass	kg	1064	<input checked="" type="checkbox"/> Mass Includes Battery
Driver and passengers	kg	75	
Electric Motor Power	kW	60	
ICE	kW		
Use Driving Cycle		weighted 20/25/55	9
Custom Cycle : Urban driving	% km		20%
Custom Cycle : Rural driving	% km		25%
Custom Cycle : Motorway driving	% km		55%

Save my calculation under number 9

Figure 1 Task 31 model user interface to design cars for GHG LCA analyses

Credible data

In annexes 1 and 2 it is explained in detail how the LCA approach has been applied and which sources for the data have been used. The LCA related data are sourced from multiple scientific publications including several scientific meta studies where a very large number of publications (dozens or more) were being evaluated. The modular approach in the model facilitates to update LCA data when available. Especially in the battery related areas the impacts can change significantly with changing chemistries, manufacturing processes, -scale and -locations. Our model can accommodate specific knowledge for all the relevant parameters and supplies best-guess defaults where parameters are unknown. The accuracy of the calculation can be demonstrated by replicating literature results. For other data like the use of the vehicle, test conditions and results, data which was already published in EU related framework projects or commissioned work has been used. Credibility and transparency of the data used is a requirement for having a credible tool.

Analysing data published by OEMs and comparing “apples to apples”

An important function of the T31 model is to make analyses looking at the impacts of certain vehicle-, use- and fuel parameters to study the impacts. Examples of these are given in the chapter Sample Outputs and some observations from these analyses are listed below. This enables the user for example to look at the impact of greening of the electricity produced in the EU, the impacts of higher battery capacities used in vehicles, higher battery densities, different use cases and so on.

Observations made from T31 model analyses:

- For a standard car, the life time GHG emissions of a BEV are approximately 50% lower than those of an average ICEV using the EU electricity mix.
- A BEV using renewable energy for recharging has close to 90% lower life cycle GHG emissions than its ICEV equivalent.
- The choice of the lithium-ion battery chemistry used has only a marginal impact on the life cycle GHG emissions of a BEV.
- In Urban driving, the life cycle GHG emissions of BEV (standard car) are about 30% of those of an average ICEV when using the EU-mix electricity. When using renewable energy to charge the vehicle the GHG emissions are 12 times lower than those of the equivalent ICEV.
- A light-weight REEV driving 80% electric has only 10% higher life cycle GHG emissions than a BEV (standard car). A PHEV driving 30% electric has GHG emissions which are slightly higher than those of the equivalent ICEV.
- For luxury segment cars, a PHEV driving 30% electric (EU-mix) has about 20% lower GHG life cycle emissions than the average ICEV in that segment. A luxury BEV has

50% lower GHG emissions than the ICEV equivalent when using EU mix electricity, 90% lower when using renewable energy. For a luxury car, the GHG savings of a BEV using renewable energy are 270 grams per kilometer compared to an ICEV.

Using T31 model to analyse and compare published GHG LCA life cycle emission data.

The T31 model is to analyse and compare published LCA data in an “apple to apple” comparison. This makes it possible for the user to evaluate the credibility of the published data or to see what changing parameters will do with the LCA impacts of that car model. If the model is further developed it has the potential to become a reference model for LCA analyses.

Published data from VW Golf, VW Up!, Nissan LEAF and Nissan Pulsar have been compared with T31 model analysis. From these comparisons, several observations have been made:

- Published data are very difficult to compare with each other as different assumptions are made for example for vehicle mileage, electricity GHG footprint, test method or real driving fuel consumption.
- Large differences are observed for the GHG emissions related to vehicle manufacturing, unclear whether this is related to inclusions or not of recycling (impacts), differences in assumptions for the manufacturing impacts on the components or the energy footprint. For the VW data, the OEM vehicle emissions are much higher than the T31 model as well as third party Spritmonitor data.
- Model T31 can be useful in making data from different sources comparable.
- A systematic analysis and comparison of OEM and other third party published data will probably be of high interest to policy makers and other stakeholders as it will provide more transparency on these published data and make them comparable.

Current status, next steps and possible future improvements

Whereas Task 31 has demonstrated that the modelling of the GHG LCA impacts is possible and can be very useful. To make it a “tool of reference”, the model needs to be reviewed by third parties and additional effort is needed to make it more robust and credible. This is having highest priority. The increasing importance of having reliable and comparable GHG emission data for cars provide a good opportunity for this as it is a clear need which currently cannot be fulfilled. To enhance the credibility additional LCA expert stakeholders can be involved in the work and a continuous effort to maintain the (LCA) data used up to date needs to be defined. A separate proposal will be defined on how this work can be defined, organized and executed.

To make the model more accurate and applicable for a wider variation in vehicle characteristics, it is recommended to make the following improvements:

- Verification and calibration of real world fuel consumption calculation with measurement data.
- Adding specific LCA data for the parts production and assembly of vehicles.
- Review and further detail the battery module as this will be one of the most important items for future developments and it is also an item about which much is published.
- Adding vans (Light Commercial Vehicles) as this is an important vehicle category for policymakers in cities and logistics companies.
- Adding other additional “alternative fuels” like natural gas, synthetic fuels and biofuels as options to impact the GHG life cycle emissions.
- An “energy” module and other modules like air quality (NO_x, PMs) can be developed and added.

2. Contents

1. Summary	2
2. Contents	6
3. Introduction	7
4. Objectives	7
5. Scope of study	9
Environmental impact chain.....	9
Impacts	10
Delimitations / caveats	10
6. The LCA (GHG) model description	11
What does the model do?	11
How can the model support policy makers?	13
7. Approach and data sources	13
Life Cycle Assessment (LCA).....	14
Tank to wheel assessment.....	14
Vehicle life cycle	15
Consolidation as input for the configuration of the LCA (GHG) model and analysis	15
8. Sample outputs	17
Example 1: impact of fuel and vehicle life span in kilometres	17
Example 2: impact of electricity GHG footprint for battery manufacturing or charging	18
Example 3: impact of the battery chemistry used on BEV GHG emissions	19
Example 4: impact of the fuel used and the driving environment on the GHG car emissions.....	21
Example 5: impact of the electricity footprint and the degree of vehicle electrification on the life cycle GHG emissions.....	22
Example 6: impact of drivetrain and car segment (weight)	23
9. Comparing the model results to published car LCAs: use of the T31 model to evaluate and compare published data	24
10. Future work and Options	29
11. References	30
12. Annex 1: Methodological Framework using LCA	33
Introduction to Life Cycle Assessment	33
Carbon footprint	34
General methodological choices in the model	34
Structure of the model	36
13. Annex 2 - Calculation Methodology	37
Control Variables and Dependencies	37
Modules.....	37
1. Glider production and decommissioning	38
Calculation procedure	39
Recycling and decommissioning	39
Data Confidence and Sensitivity	40
2. Battery production and decommissioning	40
Recycling and decommissioning	43

Data Confidence and Sensitivity	43
3. Electric motor production and decommissioning.....	44
4. Internal combustion engine production and decommissioning.....	44
5. Fuel production.....	44
6. Electricity production.....	44
7. Use of the vehicle.....	45
8. PHEV mix model.....	47

3. Introduction

Under the IEA TCP on Hybrid and Electric Vehicles, Task 31 “Fuels and energy carriers for transport” has been executed in 2016 and 2017. Supporting countries were The Netherlands (lead), Sweden and Denmark. The objective of Task 31 has been to execute a review, based on state-of-the-art, independent studies to determine the impact of different drivetrain options, fuels and vehicle use on CO₂ emissions of passenger cars. The output of Task 31 is aimed to inform policy makers in an easy way on the key environmental aspects of electric vehicles (EVs) in comparison to conventionally fueled vehicles (Internal Combustion Engine Vehicles or ICEVs). Within this first phase the focus has been on greenhouse gas (GHG) emissions. In addition, an easy to use proprietary tool has been developed to compare CO₂ emissions and energy efficiency of cars and their drivetrain and fuel options. Enabling policy makers and other stakeholders to compare and analyse GHG impacts of passenger cars is increasingly important as life time GHG impacts are receiving increased attention, and the information in media and scientific papers is to a large extent dependent on underlying assumptions. Using the model (results) gives understanding about the influential parameters in a passenger car LCA and hence which information is critical to make a complete comparison between vehicles. This helps to interpret passenger car LCA results published elsewhere. As the in-use GHG emissions of electric vehicles are zero, many stakeholders now report on life cycle based GHG emissions to compare electric vehicles with combustion engine vehicles. The sources of information and assumptions made in these published figures is not always clear and may lead to unclear or misleading conclusions.

4. Objectives

The objective is to compare current (2016) and future electric and plug-in hybrid vehicles with vehicles running on the conventional motor fuels gasoline and diesel. The model covers the full life cycle of the vehicles, consisting of the phases production, use and decommissioning (including recycling). The production chain of the fuel or electricity is included as well. The model uses independent, state-of-the-art environmental evaluations (LCA) of vehicles and their use. In Annex 1, the approach followed is described in detail.

The Task 31 work only looks at GHG (Green House Gas) emissions, expressed as CO₂-equivalents (CO₂-eq). The model is prepared to report on energy use and efficiency as well however the values (references) have not yet been defined.

The multitude of model settings enables scenario analysis on a vehicle level and can show the consequences of e.g. a changing electricity mix, or of an increasing average battery size and range of electric vehicles. In Annex 2, the model is described in detail.

The model is prepared for extension into future years, which would enable investigation of the effect of future developments in manufacturing, use and recycling. Thus, far, this has been implemented only for electricity mix compositions.

The present work provides answers to questions such as:

- How do BEVs, PHEVs and ICEVs (gasoline and diesel) compare on environmental impacts if not only direct emissions are considered but also the indirect emissions from energy production chains and vehicle production and decommissioning?
- Is the environmental impact comparison between BEV, ICEV and PHEV different for different market segments with corresponding drive patterns?
- How may future developments influence the comparison between electric vehicles and combustion engine vehicles, in terms of greenhouse gas:
 - o Efficiency improvement of combustion engine vehicles
 - o Trend towards more sustainable electricity mix
 - o Developments in battery capacities and life span
 - o Changes in driving behavior: autonomous driving, intelligent traffic systems, platooning
- What is the influence of the electricity mix on the performance of electric vehicles?
- What is the impact of PHEVs?
- What is the variation among passenger car market segments? From compact to luxurious vehicles.
- What are the impacts of the vehicle production and recycling?
- What are the impacts of the battery?
 - o Battery capacity in kWh (or weight)
 - o Battery production (using renewable energy or not)
 - o Battery chemistry
 - o Battery lifetime (in km's)
 - o Battery recycling

5. Scope of study

Vehicle classes and models: Cars (M1)

Drivetrains and fuels: Battery electric vehicles (BEVs), plug-in electric vehicles (PHEVs), gasoline (hybrid) and diesel (hybrid) models (ICEs). Fuels and energy carriers considered: diesel, gasoline, electricity. Biofuels are explicitly excluded from the assessment, because a reliable evaluation of the multitude of biofuel manufacturing and distribution pathways justifies a study of its own. For electricity, the GHG footprint is an important variable in the model.

Parameters for quantitative analyses: Energy efficiency (at vehicle level and primary energy level); CO₂ emissions (at vehicle, in-use and manufacturing, and fuel level); Fossil fuel dependency

Geographic scope: European situation (extension possible however the car type definitions used are based on the European situation)

Model: 2016 base year, the model enables to simulate (almost) any scenario for the future

Extension of scope is possible: geographical scope, other fuels (e.g. natural gas, biogas), other parameters like NO_x, PMs (particulate matter)

Environmental impact chain

An important aspect in changing to electromobility (electric drive) is the tradeoff in emissions between the use of the vehicle, the production of the energy carrier and the production and recycling of the vehicle. To evaluate the potential contribution to climate change and air pollution, each of these three parts is included in the analysis, see Figure 2.

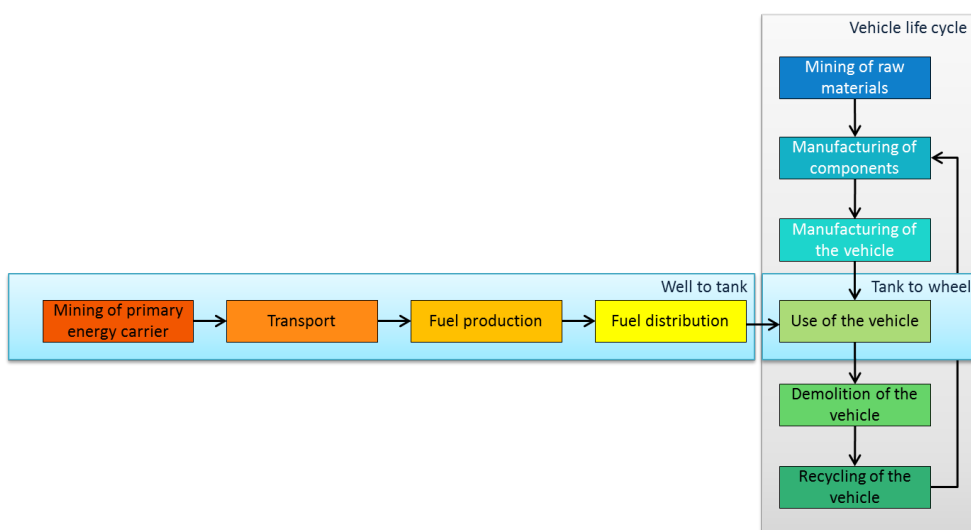

Figure 2 Scope for environmental impact assessment

Impacts

The impacts considered are:

- Contribution to climate change, because of the emission of greenhouse gases including CO₂, methane and N₂O, expressed as CO₂-equivalents using GWP-factors.

Impacts NOT in the current scope but possible as follow up:

- Emission of air pollutants (nitrogen oxides and particulate matter) and noise, and an indication of their combined impacts, expressed in external costs. Vehicle emissions include tailpipe emissions as well as brake and tire wear.

Delimitations / caveats

The present study has a level of detail that is limited by the availability of data as well as by the availability of budget. The work has focused on the Europe situation (car types, electricity mix). In some examples country specific data is used and the Dutch data on the ratio of electric drive versus combustion engine drive have been used to model the PHEV cars.

The future is difficult to predict. For instance, the decarbonisation of power generation, fuel production and vehicle manufacturing and demolition may occur quickly, or not occur at all, or at different speeds throughout the world. Impacts of such developments will therefore be assessed in the form of sensitivity analyses exploring the consequences of various possible / probable trends. The objective of the model developed is not to predict the future but to investigate the impacts of possible future pathways and thus enable policymakers to make fact based decisions.

6. The LCA (GHG) model description

2016-2020-2030

TNO innovation for life

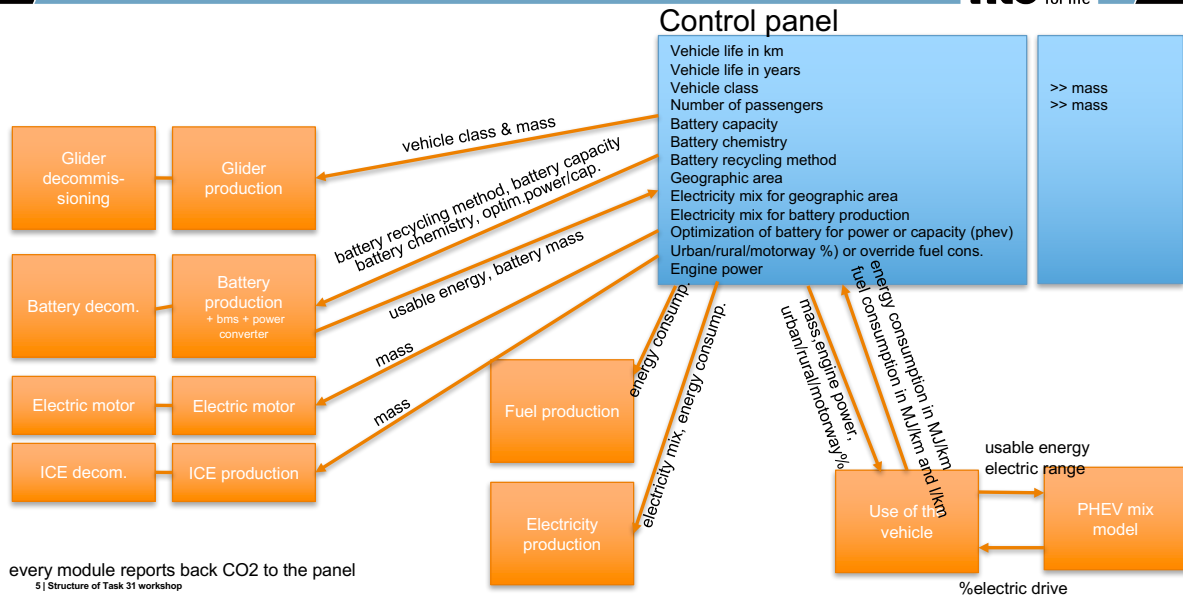

Figure 3 Schematic representation of the T31 model illustrating the different calculation modules and the control panel choices which can be modified by the user

What does the model do?

The model allows the user to define the vehicle configuration to be analysed by setting parameter values in the control panel. The model then calculates for that given configuration the life cycle CO₂ impacts. Using the control panel, existing vehicles can be simulated and compared to published data. "Virtual" vehicles can be defined as well. This allows the user to study the impact of changing one or more parameters.

In the model, the inputs are translated into a material composition of the vehicle and (if present) the battery, and into an energy demand in terms of fuel or electricity during the use of the vehicle. Simply put, these are subsequently multiplied with CO₂ emission factors per material and per energy carrier. The direct CO₂ emission is calculated as well.

The output is provided in kg CO₂ per vehicle-lifetime, and as g CO₂/km driven. The total CO₂ emission (per vehicle-lifetime and per km) is decomposed in the life phases production, use and recycling and energy carrier production. The battery production and recycling/disposal is shown separately.

Model output can be stored in one of the 25 slots. The stored information can be used to compose comparison graphs.

In chapter 8 several example comparisons have been made to determine the impact of the electricity (footprint) used, the battery capacity and the vehicle weight on the vehicle life time GHG emissions represented as grams of CO₂ per kilometer driven.

One of the options in the T31 model is the possibility to select a driving cycle. This can be either one of the standard cycles NEDC, WLTP and CADC, or a custom mix of 'real driving' in urban, rural and highway environment. Note that the NEDC setting will in principle result in higher CO₂ emissions than reported by OEMs type approval. The reason for this is that not all the flexibilities OEMs use for testing are included in the model's prediction of the energy consumption of the vehicle. Examples of these "flexibilities are using low resistance motor oil, decoupling the battery, low resistance tires, optimized test environment temperatures and so on.

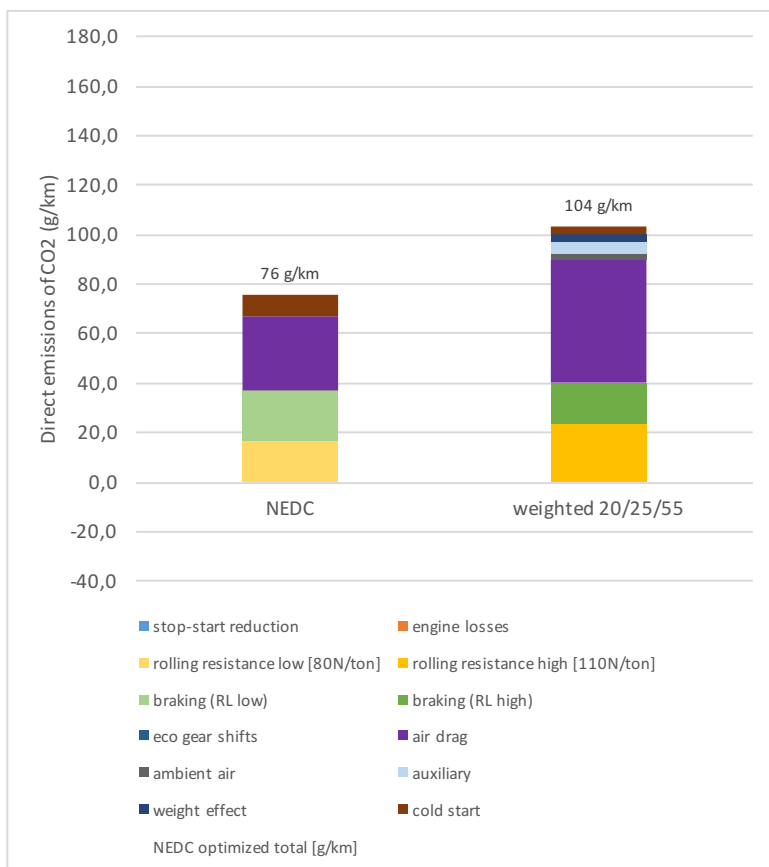

Figure 4 Example of the detail available in the T31 model (weighted 20/25/55 = 20% of the distance driven in the city, 25% on rural roads and 55% on the highway). Please read annex 2 for more details.

PHEV impacts are calculated using real world % electric-drive data (Netherlands) and other inputs, see the method and formula developed in the annex.

For scenario calculations for example for 2020, 2030 or 2050 free values can be defined for major technology trends (e.g. CO2 emissions for power generation, battery technology developments) to see impacts of different scenarios.

How can the model support policy makers?

It allows policymakers to compare CO2 emissions and energy efficiency for different car types, drivetrains in an easy manner but based on credible and peer reviewed scientific data Enabling to define parameters fitting the geographical and fuel (footprint) situation in their specific country. The user interface and free configuration of parameters enable to study impacts of changing fuel/power over time.

Providing easy to understand outcomes (comparisons) but which are based on credible peer-reviewed published scientific research results. The examples in this report demonstrate the use of the model in creating required comparisons.

7. Approach and data sources

For the model, data have been used from published sources. Several widely quoted and used meta-studies on many Life cycle assessment (LCA) studies have been used as the primary source in addition to data from Eco-invent LCA database. In the annexes 1 and 2 the approach and sources are discussed in detail.

The vehicle's energy requirement calculation is largely based on algorithms published previously in the Service Request 6 report.

Based on experience as well as on literature, the key factors are identified that determine how the life cycle of an electric vehicle compares to the life cycle of an internal combustion engine vehicle, in terms of environmental impact.

Among these key factors are:

- Size, weight, range of a vehicle
- Engine power / performance
- Engine type of ICEVs and applied emission control measures
- Fuel / energy carrier type and its production pathway
- Material composition of a vehicle, and its source (virgin/recycled)
- Use (km/year) and use pattern (urban/rural/highway)
- Driving style / driving dynamics
- Weight, chemistry, capacity and production method of the battery

This wide range of variables demonstrates the difficulty to compare vehicles using different drivetrains and fuels. The range of an electric vehicle is, depending on the assumed battery capacity, usually smaller than that of an ICE vehicle. Also, an electric vehicle may be heavier

because of the weight of the battery, and therefore require more energy for acceleration – although this is in part offset by brake energy recovery. Using free to define values for key parameters, the model allows to consider the most relevant of these (see Annex 2).

Life Cycle Assessment (LCA)

The work resulted in a life-cycle assessment of greenhouse gases from ICEVs and EVs. The life-cycle assessment is composed of well-to-tank emissions, tank-to-wheel emissions and vehicle life cycle emissions (see next paragraphs).

More information on Life Cycle Assessment in general can be found in annex 1.

The contribution to climate change was calculated using the Global Warming Potentials (GWPs) in the Fifth Activity Report of the IPCC [IPCC, 2013].

Functional unit:

Providing personal transportation* over a distance of 1 km
--

*) protected against weather influences and against crashes, with a minimum vehicle design speed of 100 km/h.

Tank to wheel assessment

Energy consumption and vehicle direct emissions are dependent on the size of the vehicle, engine technology, region of use, driving style, condition of the vehicle, temperature and other factors. The model allows the user to define the key parameters. Vehicles will be categorized per the following table.

Table 1 Vehicle segments and energy carriers

Vehicle type (segment)	Drivetrain
Small (A/B)	Petro ICEV / diesel ICEV / BEV / PHEV
Standard (C/D)	petrol ICEV / diesel ICEV / BEV / PHEV
Luxury (E/F)	petrol ICEV / diesel ICEV / BEV / PHEV
SUV	Petro ICEV / diesel ICEV / BEV / PHEV

For each category, the user is free to define a lifetime mileage as well as a representative use pattern, expressed as the shares of urban/rural/highway driving. Some standard driving

patterns are included, as well as the NEDC and WLTP test cycles, whereby the flexibilities are partially accounted for.

The vehicle lifetime and the distribution among urban rural and highway driving both have a significant impact on the environmental impact per kilometer of each vehicle type.

The tank to wheel assessments for ICEVs were based on the SR6 report [Ligterink, 2016] and a general understanding at TNO of the factors that influence the energy consumption of a vehicle. For the present project, the tank to wheel assessment is extended for electric and plug-in electric vehicles, using component efficiency factors provided by Chalmers University and VUB. For plug-in hybrid vehicles, an estimation is made of the percentage of kilometers driven electrically. This was done based on actual data for different models with different battery capacities. More information about the tank to wheel modelling can be found in annex 2.

Vehicle life cycle

The production and demolition and recycling of vehicles is covered from mining of raw materials to delivery of the vehicle, and from scrapyard to recycling facilities. Data for the various materials and processes were collected for European averages from the Ecoinvent 3.3 database, and validated against existing LCA literature. This should allow a high degree of comparability as Ecoinvent is the most common primary source used in the literature. If possible the sources underpinning the LCAs are used directly to enable consistent modelling of environmental impact over different vehicle sizes, weight and battery capacities.

Emissions in the vehicle life cycle are influenced as well by the location of the manufacturing and recycling activities. Vehicles and components may be manufactured in Europe, the US, Japan or elsewhere, and regardless where the manufacturing takes place, the steel, aluminum, plastics and electronics may be sourced from a different part of the world. Moreover, the impact is dependent on the exposure: in densely populated areas an emission would give rise to a larger effect than in a non-densely populated area.

A practical approach is followed: where available, worldwide average data will be used. Insofar single materials or processes influence the total greenhouse gas emission or air pollutant emission; a sensitivity analysis will be made to show the robustness. If needed, the analysis is fine-tuned. If possible, information is collected about which part of the emissions takes place in urban areas. The calculation of external costs makes it possible to distinguish the effect.

Phases that are not different between ICEVs and EVs, e.g. transport of the vehicle from the factory to the dealer or customer have been neglected.

Consolidation as input for the configuration of the LCA (GHG) model and analysis

The collected literature data is used as input for the LCA (GHG) model which has been developed to determine the GHG emissions for the vehicle life cycle GHG emissions. The

user can define input parameters through an input screen an example of which is shown in the figure below.

Parameter	Unit	Value
Vehicle Life	km	252000
Vehicle Class/Chassis Composition		SUV 2
Vehicle Drivetrain Type		Diesel 2
Electricity Mix (Use)		EU 28 mix 1
Electricity Mix (Battery Production)		EU 28 mix 1
Electricity Mix (Chassis Production)		EU 28 mix 1
Battery Chemistry		No Battery 1 <input type="checkbox"/> Use Ellingson 2014 for manuf. (high outlier)
Battery Capacity	KWh	75
Battery Mass	kg	0 <input type="checkbox"/> Entry overrides mass instead of recal. kWh
Battery Cell Recycling		Hydro 3
Vehicle Mass	kg	2230 <input checked="" type="checkbox"/> Mass Includes Battery
Driver and passengers	kg	75
Electric Motor Power	kW	34
ICE	kW	190
Use Driving Cycle		weighted 25/30/45 8
Custom Cycle : Urban driving	% km	20%
Custom Cycle : Rural driving	% km	25%
Custom Cycle : Motorway driving	% km	55%

Save my calculation under number 15

Figure 5 Task 31 model user interface to design cars for GHG LCA analyses

Each study has its own scope and depth. Even LCA studies reported in accordance with the ISO 14040/14044 standards and other guidelines such as the ILCD Handbook can differ significantly amongst each other. Moreover, vehicles discussed in one source may not have the same specified functionality, such as load capacity for trucks, as vehicles in another source.

The aims of the consolidation are:

- To create consistent vehicle data sets for well-to-tank, tank-to-wheel and vehicle life cycle data
- To create vehicle cases with comparable functionality/performance among BEVs, PHEVs and ICEVs
- To develop a parametrized model for structuring the comparison of environmental impacts for vehicles in different segments
- To translate data obtained from literature into input data for the model
- To calculate impacts for several scenarios with respect to the input data and specifications of the compared vehicles

The consolidation has been done by matching literature data. The rules to scale or otherwise interpret the data to perform the matching, are derived from the variety of literature. A model will be built that contains the derived rules, for example the relation between

environmental impact and the weight of a vehicle (excluding battery), or the relation between a fuel's direct emissions and the impact of its production. The relation between vehicle use and fuel consumption will be included as well, based on TNO experience with measurements in this field.

Note that modelling does not average out different sources, but just performs transparent scaling and adjusting of the scope where necessary.

Next, vehicle cases were constructed for both passenger cars that fulfil matching minimum requirements in terms of power to weight ratio and minimum range, as described above.

8. Sample outputs

In this chapter several examples are given of outputs of the T31 model. The purpose of the examples is to demonstrate the use of the T31 model to give the user an idea how the T31 model can be used.

Disclaimer: *The following results assume batteries will be recycled and that they are made in Europe; the current reality is that batteries are not recycled (but will be soon in Europe), and most batteries are made in China, Japan and the US, implying a higher CO₂ density. Under these conditions, the figures presented (concerning the batteries) would be approximately 50% higher. This of course for the values calculated by the T31 model.*

Example 1: impact of fuel and vehicle life span in kilometres

In this analysis, for a standard car the life cycle GHG impacts (in g CO₂-eq per km) are calculated for different fuel options and life time kilometres driven. For the BEV car, the battery size has been varied as well.

For a standard car (vehicle weights: diesel 1.295 kg, gasoline 1.205 kg, BEV 1.525 kg) using the current EU-mix electricity GHG emissions, the GHG life time emissions for a BEV (between 80 and 100 gCO₂-eq/km) are around 50% lower than those of the comparable ICEVs (100 – 200 gCO₂-eq/km). The variations related to the fossil fuel used, battery size or life time mileage are around 10 gCO₂-eq per kilometre. For all drivetrains compared, the in-use GHG emissions are dominating (figure 6). The WTT GHG emissions of the gasoline car are, perhaps surprisingly, 50% higher than those of the diesel car, the source used for these data is the Ecoinvent 3.3 database.

For the BEV scenarios, a larger capacity and therefore heavier battery has an impact on the GHG emissions related to the manufacturing of the battery as well the in-use GHG emissions. Double the battery capacity (weight) results in a about 10% higher energy requirement for driving. For the EU-mix electricity (2016), this results in 7 g CO₂-eq per

kilometres additional WTT emissions. In addition to this, the manufacturing of the larger battery increases from 10 to 19 gCO₂-eq for a life time distance driven of 252.000 kilometres (14.000 per year for 18 years). A higher life time mileage reduces the per kilometre impact of the manufacturing of the battery but of course not those of the in-use phase. The higher mileages can be relevant for example for cars being used as taxi or in car-sharing schemes, assuming the technologies can deliver this life time mileage.

Observation: For a standard car, the life time GHG emissions of a BEV are approximately 50% lower than those of an average ICEV using the EU electricity mix.

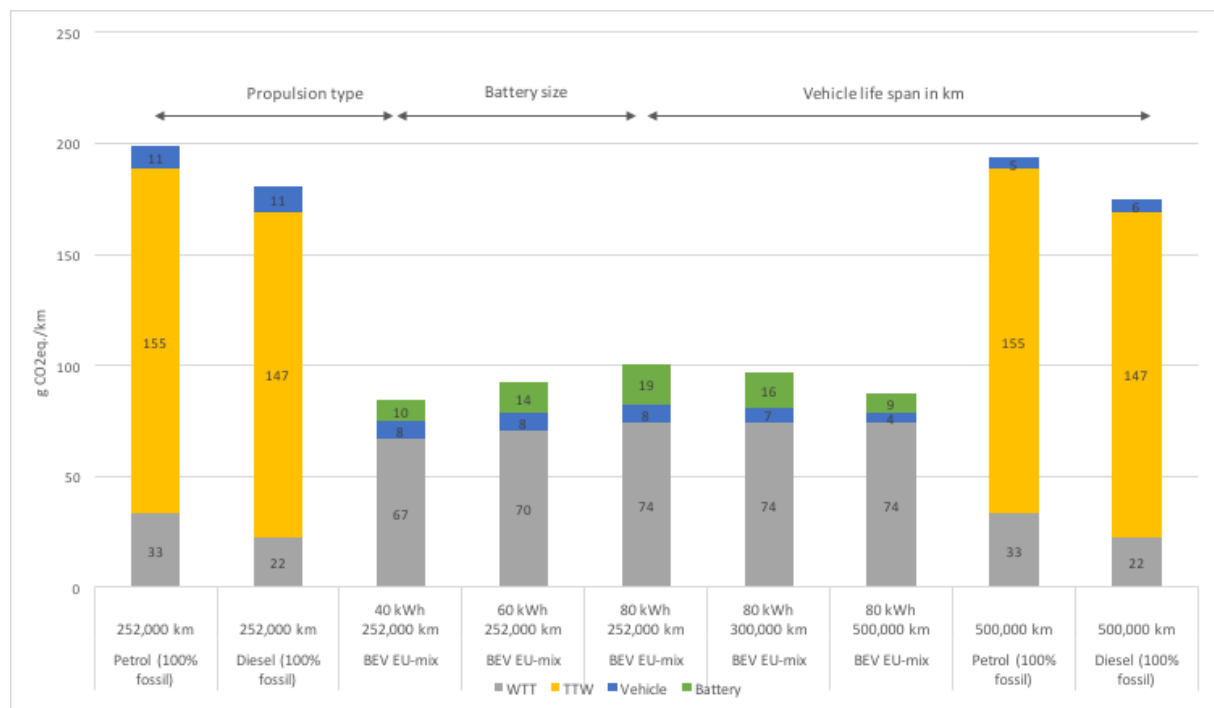

Figure 6 Impact of fuel, battery size and life time use (km) for standard size cars. The battery is assumed to be recycled in this analysis

Example 2: impact of electricity GHG footprint for battery manufacturing or charging

In figure 7, the results of an analysis looking at the impacts of the electricity source on the life time GHG emissions of BEVs are shown. The most evident observation is that using renewable energy for charging a BEV has by far the largest impact of the GHG life time emissions. For the standard vehicle analysed, a BEV charged with renewable energy has a GHG footprint almost 10 times smaller than that of an ICEV or 20 gCO₂-eq per kilometer compared to 190 gCO₂-eq per kilometer for the average ICEV. The electricity source used for the manufacturing of the battery has also a significant impact as does recycling of the battery. From this analysis is it clear that the source of the electricity used for charging the

vehicle is by far the single most important factor determining the BEV life time GHG footprint.

Using the EU-mix electricity for the manufacturing of the battery without end of life recycling contributes 14 gCO₂-eq per kilometer, recycling the battery reduces this to 10 and using renewable energy for the manufacturing of the battery reduces this further down to 6 gCO₂-eq per kilometer. This demonstrates that the electricity source used for the battery manufacturing and recycling of the battery can reduce the GHG footprint of the battery with more than 50%. With a lowering of the GHG footprint of the electricity used for charging, the impact of the battery becomes more significant and in the case of using renewable energy for charging, the battery becomes the largest GHG emission source of a BEV.

Observation: A BEV using renewable energy for recharging has close to 90% lower life cycle GHG emissions than its ICEV equivalent.

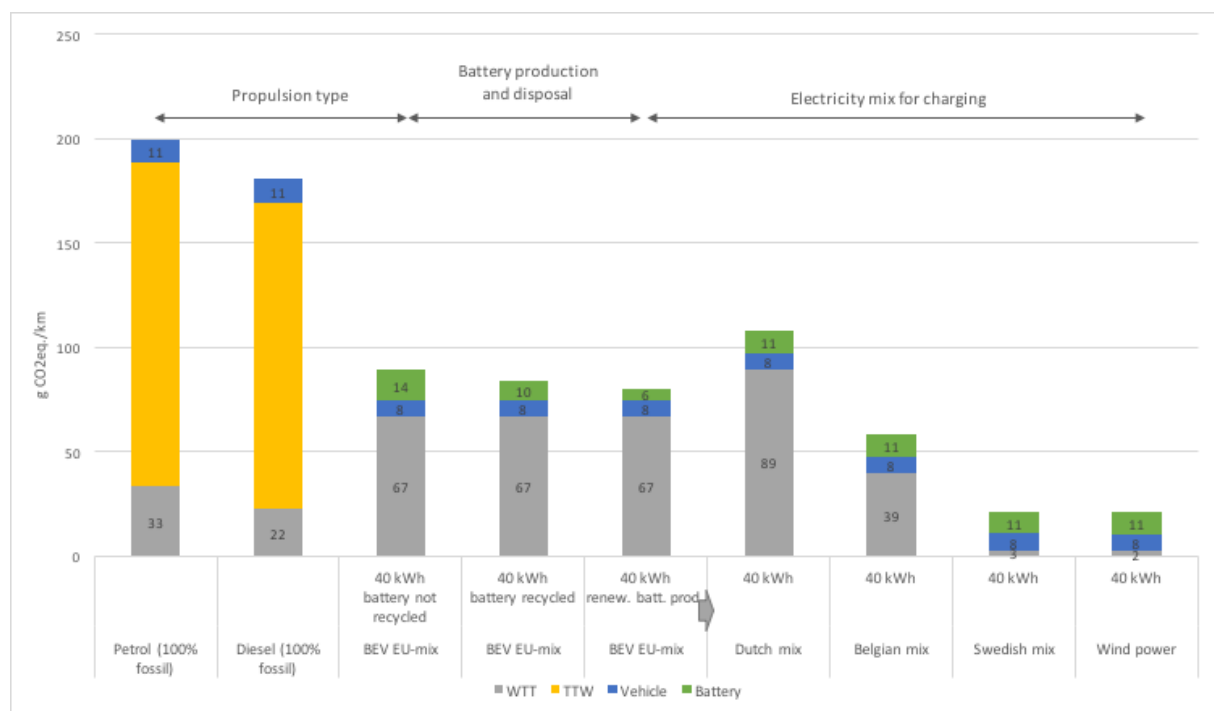

Figure 7 Impact of electricity GHG footprint for battery manufacturing or for charging compared to ICEVs GHG emissions

Example 3: impact of the battery chemistry used on BEV GHG emissions

Lithium-ion batteries can be made using different chemistries for electrolyte material. In figure 8 some of the most commonly used chemistries for EVs are listed. Lithium-ion battery manufacturing is a rapidly evolving area in which also chemistries continue to evolve, notably the amounts and ratios of the different metals used continues to be optimized.

Chemical Name	Material	Abbreviation
Lithium cobalt oxide	LiCoO_2	LCO
Lithium manganese oxide	LiMn_2O_4	LMO
Lithium iron phosphate	LiFePO_4	LFP
Lithium nickel manganese cobalt oxide	LiNiMnCoO_2	NMC
Lithium nickel cobalt aluminum oxide	LiNiCoAlO_2	NCA
Lithium titanate	$\text{Li}_4\text{Ti}_5\text{O}_{12}$	LTO

Figure 8 The most common lithium-ion chemistries. The different chemistries have different impacts on battery safety, energy density, power density, cycles for charging and de-charging and cost. Other aspects like the anode, cathode and the specific use of the battery will play an important role as well

In figure 9, the impact of the different chemistries used on the BEV life time GHG emissions is shown. The small difference in the WTT emissions are due to the differences in the battery weight. The LFP (lithium iron phosphate) has a lower energy density and therefore a higher weight. For passenger cars, NCM (or NMC) and NCA are most commonly used technologies, for buses LFP is used in China for its low cost and high safety performance. The LFP chemistry has a higher GHG impact both for the manufacturing of the battery as the use of the vehicle but the differences are limited. This is an important observation as it makes it possible to ignore the battery chemistry for most GHG impact analyses. Cobalt is a material listed as critical for the EU however.

Observation: The choice of the lithium-ion battery chemistry used has only a marginal impact on the life cycle GHG emissions of a BEV.

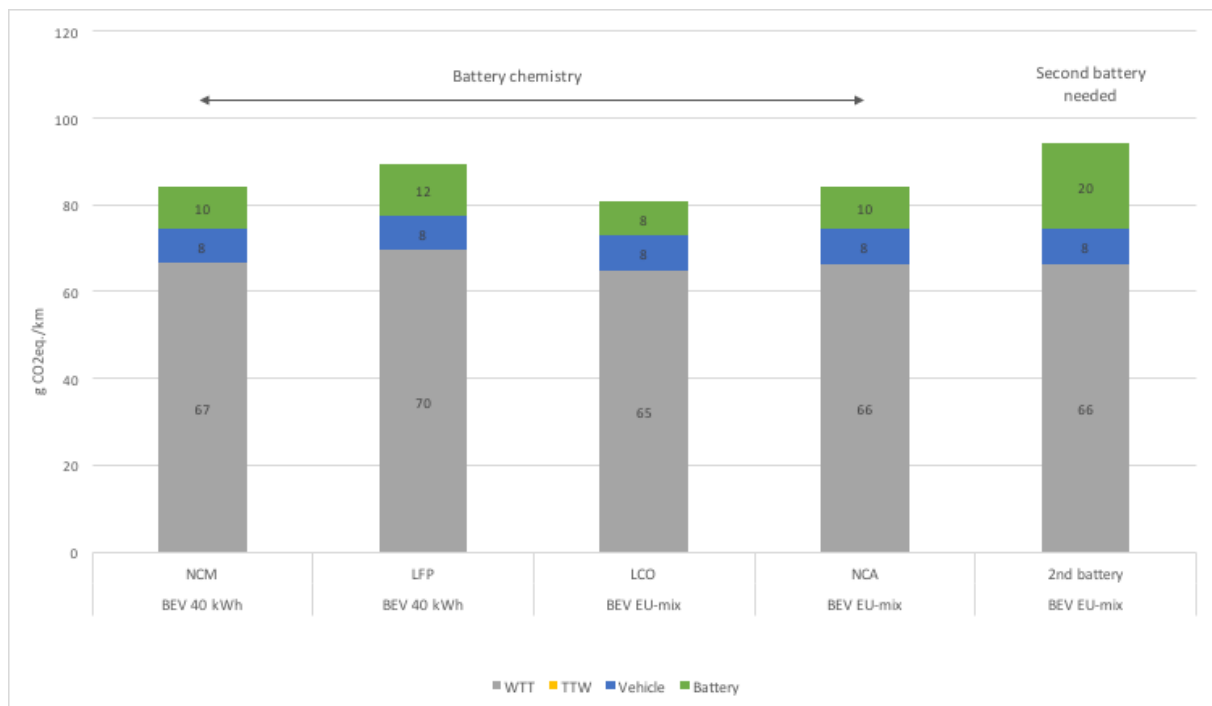

Figure 9 Impact of the battery chemistry used on the life time GHG emissions. For all vehicles, a 40 kWh battery is being used and the electricity for charging the battery is in all cases EU-mix 2016. LCO has a very high cobalt content and is too expensive for EVs. Recycling is included in the impacts.

Example 4: impact of the fuel used and the driving environment on the GHG car emissions

In figure 10, the impact of the fuel type and the driving environment (urban, highway or mixed) are compared. In the comparisons in the previous examples, the standard drive cycle used is 25% urban drive, 30% rural and 45% highway drive (in kilometers). For this and taking the EU-mix electricity BEVs have a life time GHG emission impact which is a little over 50% lower than that of an ICEV (standard car). However, when looking at urban drive only the BEV GHG emissions decrease with more than 10% while the ICEV GHG emissions increase with more than 20%. The result of this is that for urban driving a BEV (standard car) charging with EU-mix electricity has a GHG life cycle emission which is more than three times lower than the ICEV emission. A BEV using renewable energy will have GHG life cycle emissions which are a factor 12 lower than those of an ICEV. For highway driving the BEV (EU-mix) has around 40% lower GHG life cycle emissions than an ICEV while using renewable energy a BEV will have a 9 fold lower GHG life cycle emission (taking the data from figure 7 for the renewable energy impact). As demonstrated in this example, the drive environment is an important factor and as such the T31 model can help urban planners with estimating the impact of a transition to electric drive for their specific environment.

Observation: In Urban driving, the life cycle GHG emissions of BEV (standard car) are about 30% of those of an average ICEV when using the EU-mix electricity. When using renewable

energy to charge the vehicle the GHG emissions are 12 times lower than those of the equivalent ICEV.

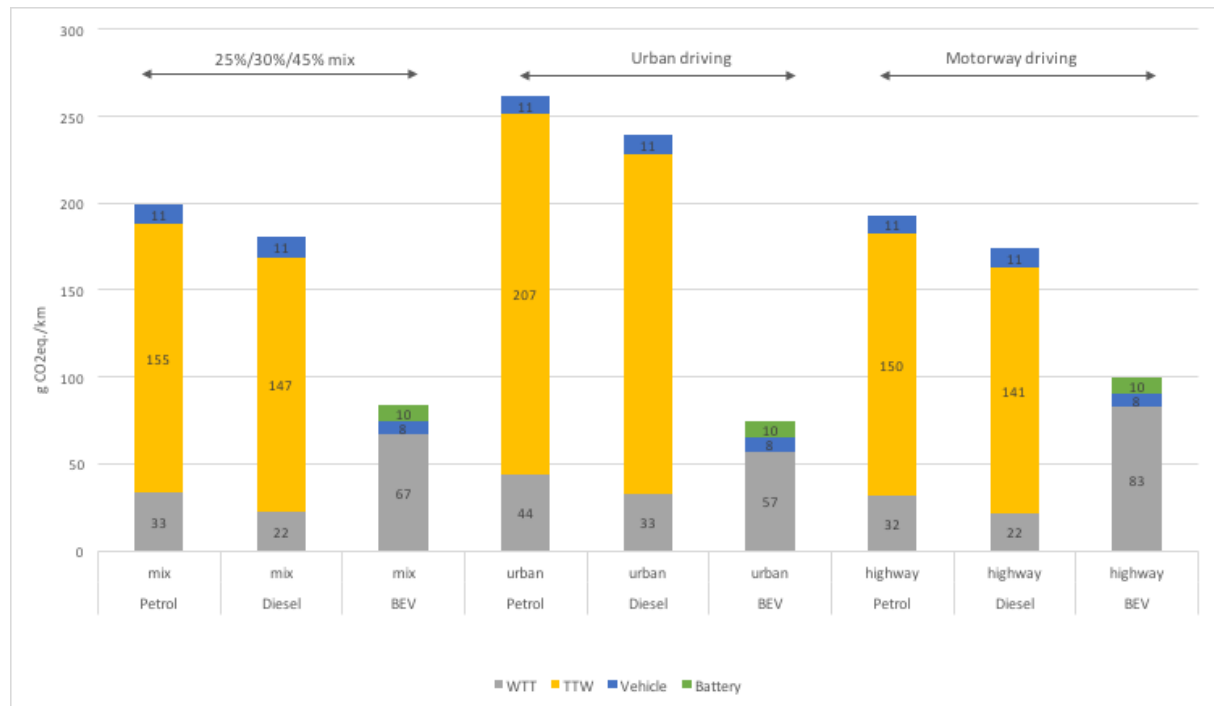

Figure 10 Impact of fuel and drive cycle

Example 5: impact of the electricity footprint and the degree of vehicle electrification on the life cycle GHG emissions

In figure 11, the impact of the electricity source on the BEV GHG emissions is shown. Next to the impacts of using the EU-mix and renewable energy, the impacts of using electricity by natural gas or coal are given. The use of natural gas to generate electricity leads to vehicles life cycle emissions which are about 20% higher than when using the average EU electricity (“EU-mix”) but the BEV emissions remain lower and are about 60% of the ICEV average GHG emission. Using 100% coal generated electricity leads to 20% higher emissions than the ICEV GHG emissions.

For the impact of the vehicle electrification, a BEV, a REEV driving 80% electric (BMW i3), a PHEV (driving 30% electric) and two ICEVs are compared. Data on the percentage of electric drive of PHEVs is still scarce. We have good data from the Netherlands which shows an overall 30% electric drive over several years of study among thousands of PHEVs. A recent study from Norway shows 55% electric drive (Feigenbaum, TOI, Institute of Transport Economics, Norway). Electricity used for charging is the EU-mix. The REEV GHG emissions are about 10% higher than those of the BEV, as can be seen from the battery data the battery size is significant (19 kWh). For the PHEV, the GHG life cycle emissions are higher than those of the ICEVs. The combination of the low e-drive and the higher vehicle manufacturing

emissions result in a vehicle which has no GHG overall benefits. It demonstrates that for REEVs or PHEVs the way the vehicle is used determines whether there are GHG benefits or not.

Observations: A light-weight REEV driving 80% electric has only 10% higher life cycle GHG emissions than a BEV (standard car). The PHEV standard car driving 30% electric has GHG emissions which are slightly higher than those of the equivalent ICEV.

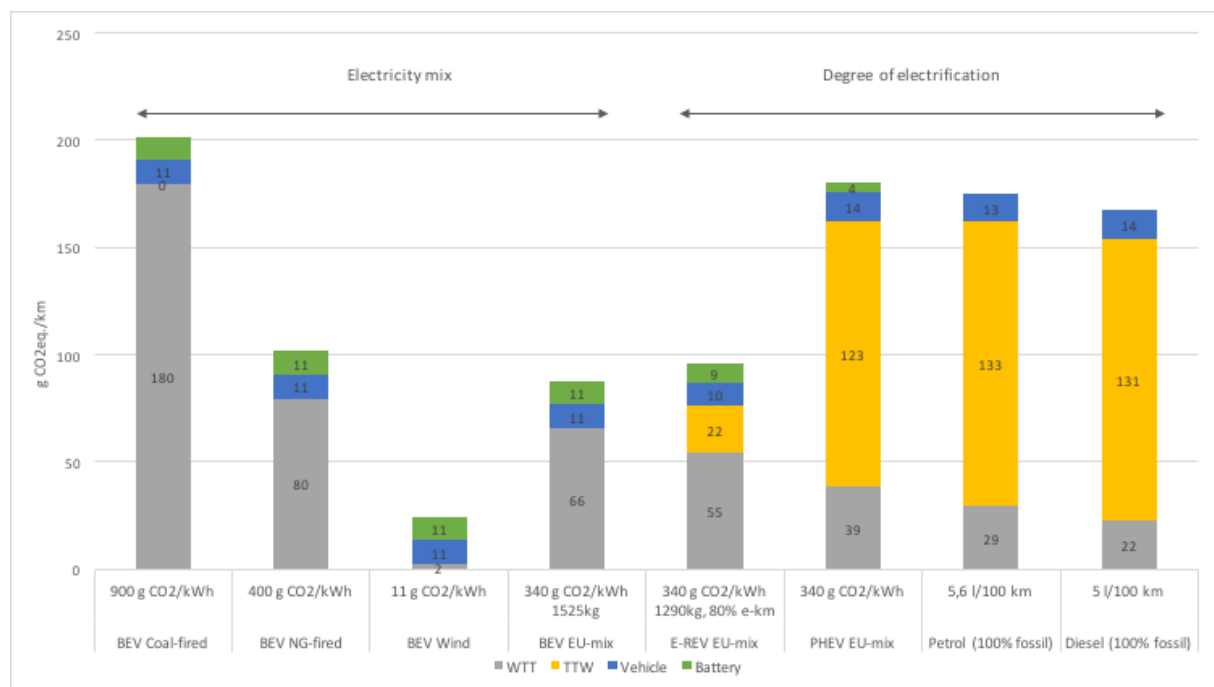

Figure 11 Impact of the electricity GHG footprint and the degree of electrification of the vehicle

Example 6: impact of drivetrain and car segment (weight)

Figure 12 shows the GHG life cycle emissions of the drivetrain in combination with the car segment. No surprises in that the larger cars have much higher GHG emissions but interestingly for the luxury cars the differences of the different drivetrains are more pronounced. The PHEV luxury car has a significantly lower GHG emission than the ICEVs. The reason for this is that the emissions related to the use of diesel or gasoline almost double but the emissions related to the use of electricity only increase slightly as can be seen comparing the standard and luxury car emissions. For luxury and SUV cars, the emissions of the BEV are as a percentage lower (46% of average ICEV) than for the standard car (50%) when compared to the ICEV. However, the largest impact comes from the absolute difference in g CO2-eq per kilometer when changing from ICEV to BEV, for the standard car this is around 90 grams per kilometer whereas for the luxury car this is around 150 grams. Using renewable energy for charging will reduce the luxury BEV emissions to 30 g CO2-eq

per kilometer or 270 g per kilometers less than the ICEV luxury car. For the luxury BEV, a battery capacity of 75 kWh is taken and a life time distance of 252.000 kilometers driven. For city drive (not analysed here) this difference will even be larger, also these large cars will in practice drive more kilometers. This examples demonstrates the use of the T31 model in determining the impacts per car segment, or even per car model if needed.

Observations: For luxury segment cars, a PHEV driving 30% electric (EU-mix) has about 20% lower GHG life cycle emissions than the average ICEV in that segment. A luxury BEV has 50% lower GHG emissions than the ICEV equivalent when using EU mix electricity, 90% lower when using renewable energy. For a luxury car, the GHG savings of a BEV using renewable energy are 270 grams per kilometer compared to an ICEV.

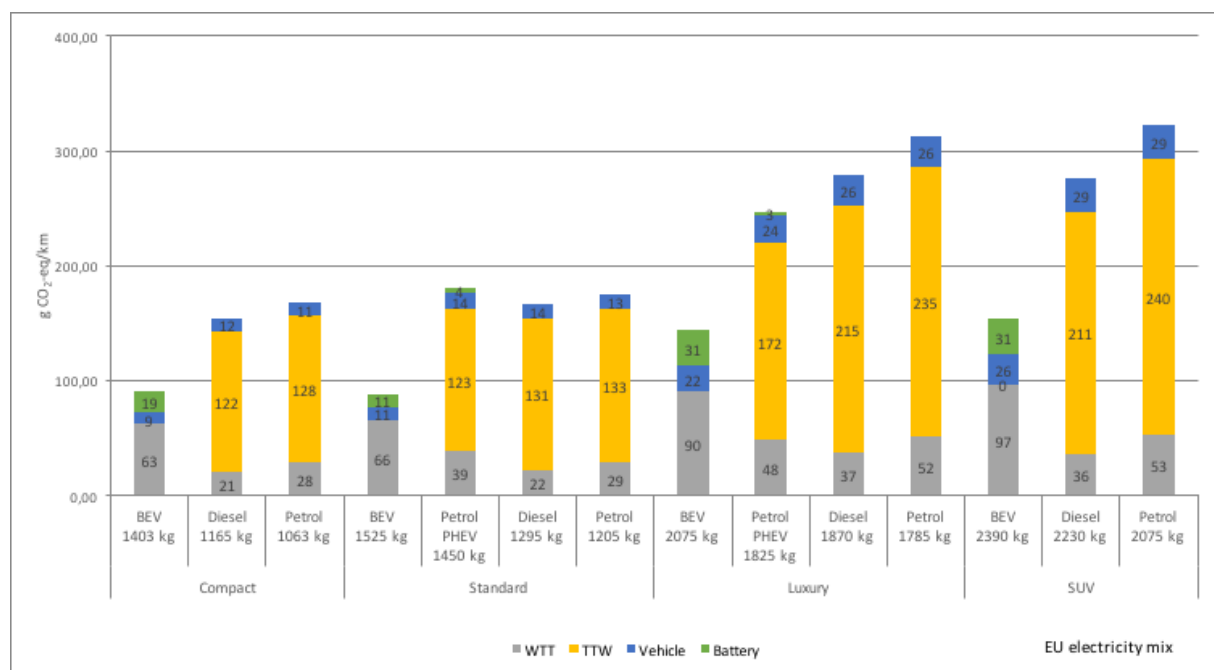

Figure 12 Impact of drivetrain and car segment

9. Comparing the model results to published car LCAs: use of the T31 model to evaluate and compare published data

Part of the interest of the model is to use it to compare (full life cycle or not) GHG emissions as published in the scientific literature or reported by OEMs or other stakeholders with data from the model. The model allows to use many the assumptions made by the OEMs like to

electricity mix used, battery capacity or distances travelled. As such, the T31 tool can be helpful for the user to evaluate LCA GHG data published and get a first assessment on the quality and meaning of the published data.

This has been done for LCAs of VW Golf; VW UP, Nissan LEAF and Nissan Pulsar. Additionally, real world fuel consumption data have been derived from Spritmonitor.de, where car owners can report their actual consumed fuel (or electricity) and distances driven. These data have been compared to the fuel consumption prediction in the model.

Disclaimer: *The following results assume batteries will be recycled and that they are made in Europe; the current reality is that batteries are not recycled (but will be soon in Europe), and most batteries are made in China, Japan and the US, implying a higher CO2 density. Under these conditions, the figures presented (concerning the batteries) would be approximately 50% higher. This of course for the values calculated by the T31 model.*

Case study: VW Up!

A battery electric VW Up and a petrol propelled VW Up have been modelled using the T31 model. The results were compared to the LCA data published by VW (The e-Up Environmental Commendation – Data sheet). Furthermore, the T31 fuel and electricity consumption has been checked with data from Spritmonitor.de. See figure 13.

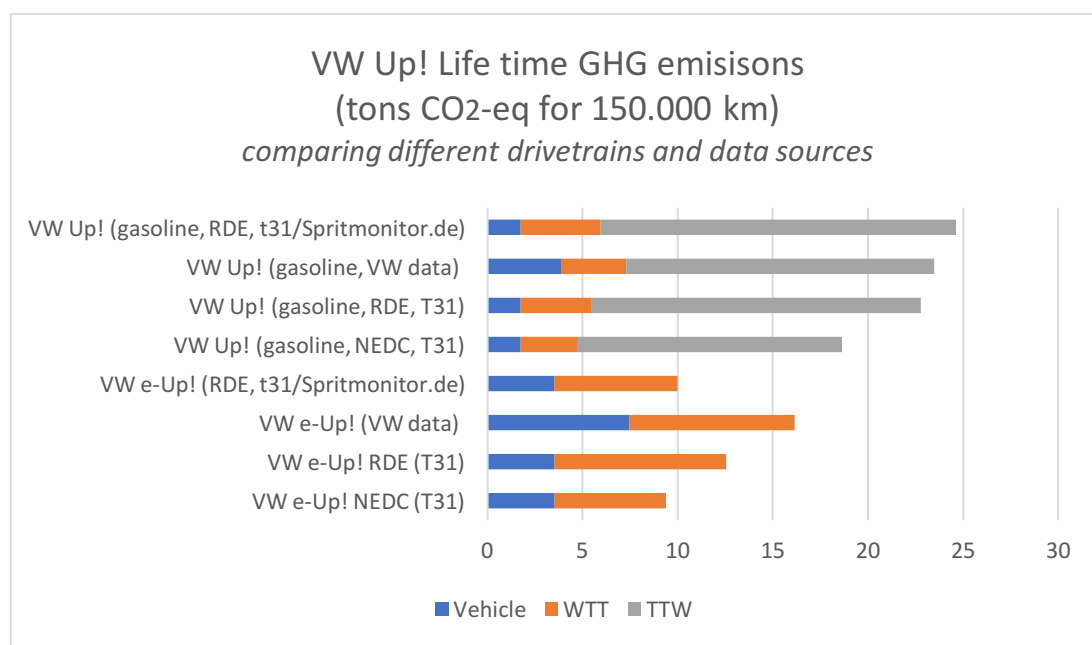

Figure 13 VW e-Up! and VW Up! published GHG LCA data compared to T31 model analyses

As can be seen in the figure above for the VW e-Up!, the electricity consumption predicted by the T31 model is overestimated, if the real world data from Spritmonitor is considered the reference. The gasoline consumption of the Up is slightly underestimated by the T31

model. Compared to the VW published data a significant difference is observed. VW reports much higher production emissions, possibly because recycling benefits are not accounted for as they are in the T31 model. Also, the e-Up! emissions during use (electricity, NEDC cycle) reported by VW are higher, because the CO₂ emission per kWh used by VW is higher.

Case study Nissan LEAF and Nissan Pulsar

For the Nissan LEAF, the energy consumption as calculated with the T31 model is compared with the data from Spritmonitor and the official NEDC type approval consumption. The NEDC T31 model value is slightly lower than the official NEDC value, while the opposite would be expected since the NEDC tests are “optimized”. The model T31 RDE value on the other hand is significantly higher than the Spritmonitor value. This means that, if we trust the Spritmonitor values, there are unexplained factors that need consideration in the next version of the model. From another source of Nissan LEAF drivers, we know that the energy consumption varies from driver to driver and use to use, values between 13.5 and 25 kWh per 100 km.

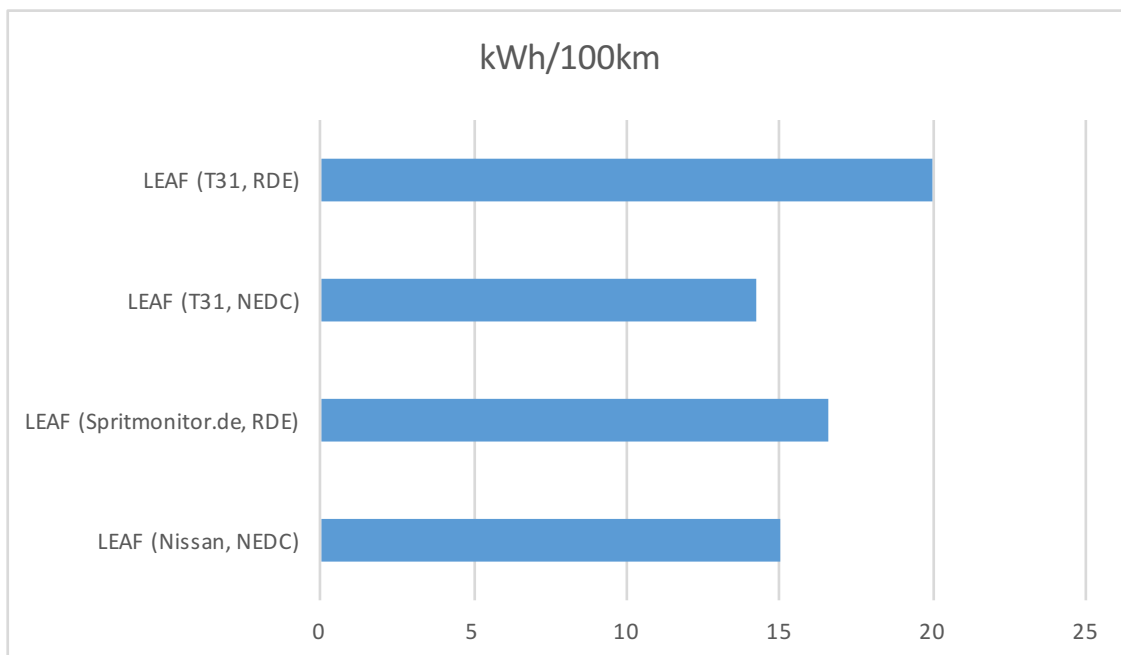

Figure 14 Nissan LEAF T31 model, NEDC type approval data and Spritmonitor energy consumption

For the Nissan Pulsar, a gasoline car of a size comparable to the Nissan LEAF, the values as found for the T31 model, NEDC and Spritmonitor are conform expectations: NEDC type approval (test) with the lowest consumption, T31 NEDC somewhat higher and RDE values significantly higher.

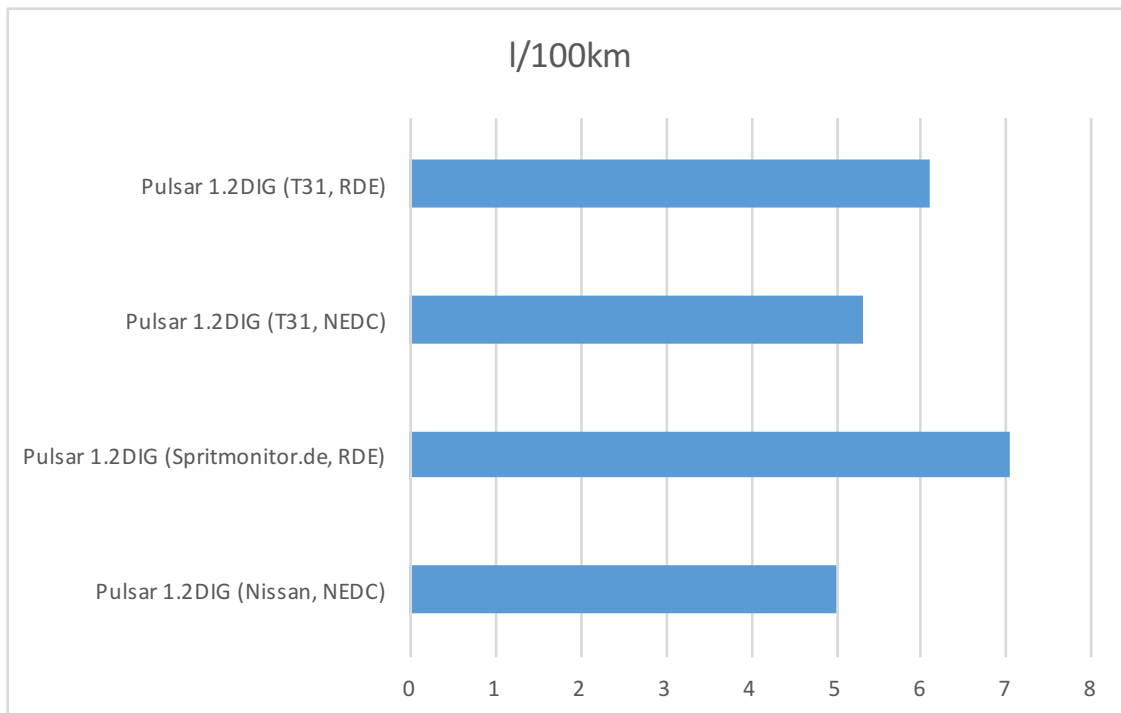

Figure 15 Nissan Pulsar T31 model, NEDC type approval data and Spritmonitor energy consumption

Case study: VW Golf

In figure 16 A, T31 model simulations of VW Golf (generation VII) vehicles types (BEV, PHEV, gasoline and diesel) are given as well as VW (generation VII) LCA data for the diesel and gasoline version obtained from VW publications. However, when looking at the different assumptions made for doing these calculations it is evident the data cannot be compared on a one to one basis. VW uses the results from the NEDC (“optimized”) test data whereas the T31 model in this cases has used the RED values. VW uses 150.000 as LCA unit whereas the T31 model has used 200.000 km. This is an example of the typical difficulties encountered when trying to compare LCA data from different sources, the starting points and/or assumptions are rarely the same resulting in trying to compare “apples with pears”.

Figure 16 B shows the same LCA data but made comparable, in this case by using the same life time vehicle mileage and the NEDC test as starting point. T31 calculates higher GHG emissions for the gasoline and diesel versions with less difference between gasoline and diesel. The PHEV Golf has emissions comparable to those of the ICE versions. The vehicle manufacturing emissions are higher than reported by VW, which may again be related to VW not accounting recycling credits and perhaps other assumptions for the vehicle GHG emissions. A further detailed analysis would be needed in this case. The relatively modest percentage of kilometers driven electrically is just sufficient to off-set this.

Even when making the VW and T31 model analyses comparable, the TTW T31 GHG emissions for the gasoline and even more so for the diesel version are significantly higher. This may be explained, at least partly, by the NEDC “optimization” as done by OEMs. The T31

model calculates the same GHG TTW emissions for the gasoline and diesel versions, however the diesel car is heavier and has an engine with a higher power. Also, in liters there is still an advantage for the diesel car as 131 g CO₂ per kilometer corresponds with 5.0 liters of diesel per 100 kilometers while the 133 g CO₂ per kilometer for gasoline corresponds with 5.6 liters of gasoline per 100 kilometers.

A more detailed analysis is required to explain the differences observed but the examples shown demonstrate the usefulness of the T31 model to make the data comparable to each other. Any differences left come from different data used for the LCAs or different assumptions made. This allows the user to focus on the real differences of the LCA outcomes instead of having to guess what the impacts of differences like vehicle mileage, test method, driving modes and so on are.

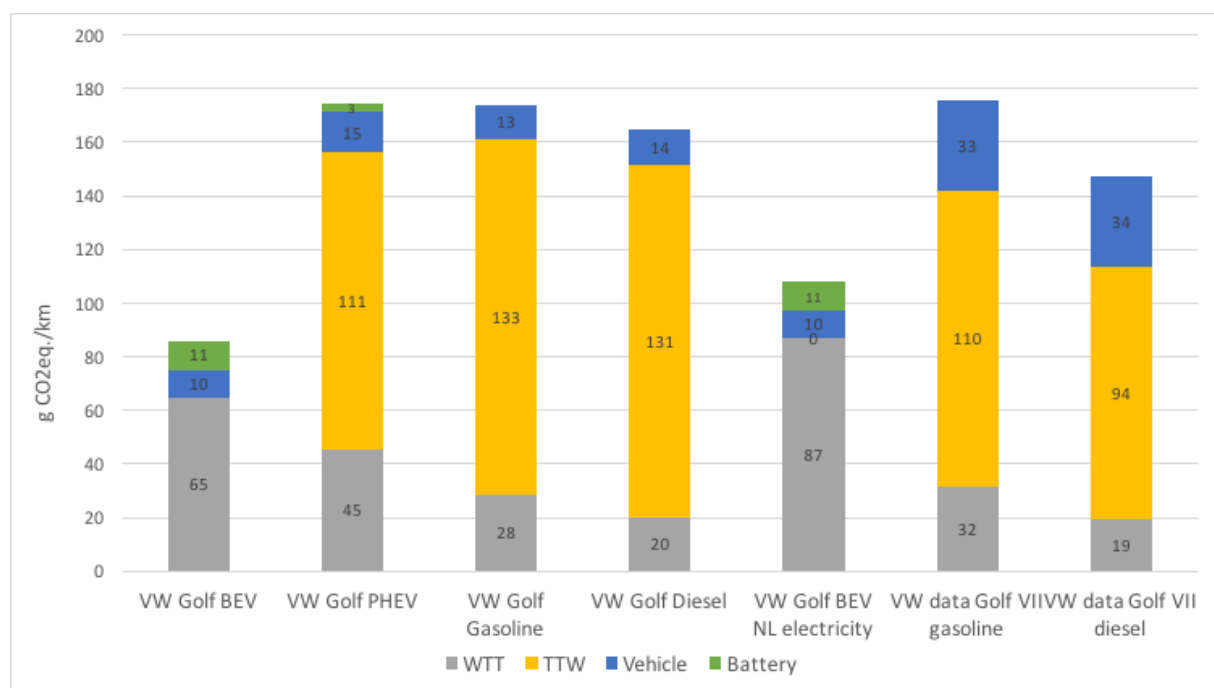

Figure 16 A “Apples and pears comparison” VW Golf (generation VII) GHG LCA emissions per kilometer comparing T31 model and VW LCA calculations (“VW data”); the example is to show the current difficulty in comparing LCA data as published, please NOTE: the T31 and VW data cannot be compared 1 to 1: VW uses a 150.000 km used as LCA unit, T31 200.000 km life time; VW uses the NEDC test results, T31 the RDE emissions

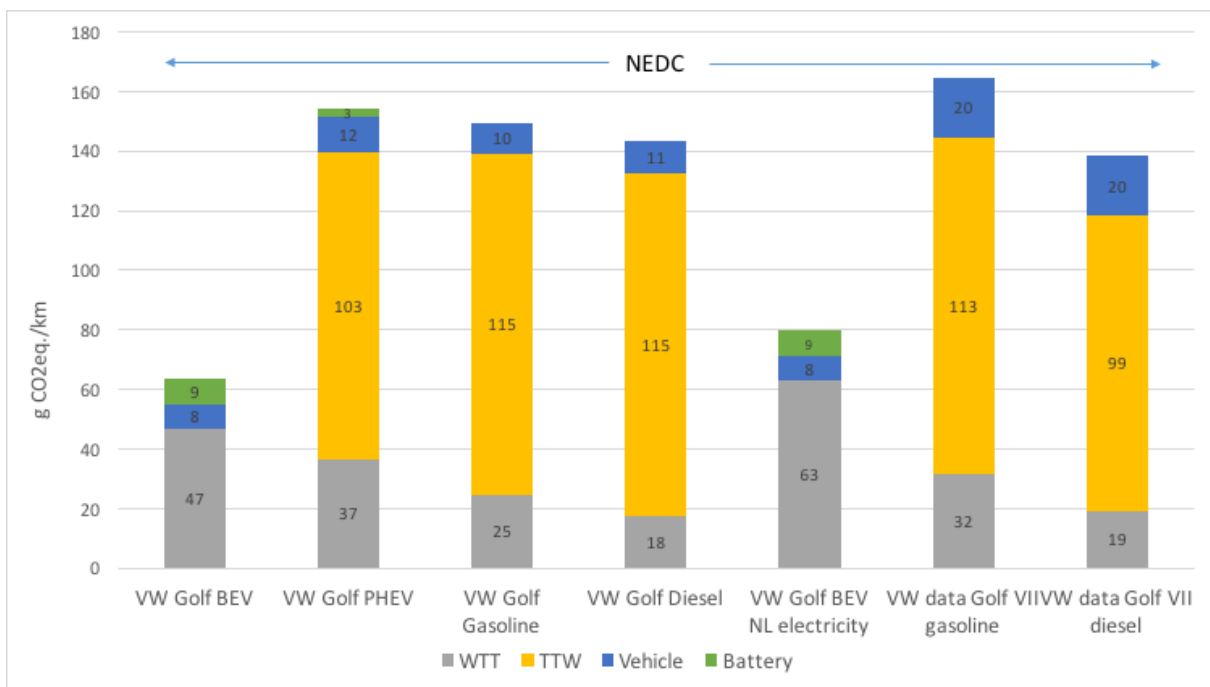

Figure 16 B “Apples and apples comparison” Comparison T31 VW Golf “NEDC” and VW data “NEDC”: in this comparison, the data as provided by VW are aligned with the T31 data, for the VW data the life time km is adapted to 252.000 km and the T31 model has calculated the NEDC GHG emissions. Please note that as mentioned the T31 model does not “optimize” the NEDC results as do OEMs

10. Future work and Options

The objective of the Task 31 was to give insights in the GHG life cycle emissions as well as being able to compare literature data with the Task 31 outcomes. The approach of Task 31 has been to build a model using LCA data from literature in combination with the in-house knowledge to build a model which can determine the GHG LCA impacts of cars using different fuels, drivetrain technologies, drive cycles and vehicle use. Because the user can by the means of a user-friendly interface define almost any car type, fuel and vehicle use it makes it possible to make “bottom-up” analysis for different scenarios. The T31 model has also demonstrated the usefulness in reviewing published LCA data and to make it possible to compare these with other findings.

Whereas Task 31 has demonstrated that the modelling of the GHG LCA impacts is possible and can be very useful. To make it a “tool of reference”, the model needs to be reviewed by third parties and additional effort is needed to make it more robust and credible. This is having highest priority. The increasing importance of having reliable and comparable GHG emission data for cars provide a good opportunity for this as it is a clear need which currently cannot be fulfilled. To enhance the credibility additional LCA expert stakeholders can be involved in the work and a continuous effort to maintain the (LCA) data used up to date needs to be defined. A separate proposal will be defined on how this work can be defined, organized and executed.

To make the model more accurate and applicable for a wider variation in vehicle characteristics, it is recommended to make the following improvements:

- Verification and calibration of real world fuel consumption calculation with measurement data.
- Adding specific LCA data for the parts production and assembly of vehicles.
- Review and further detail the battery module as this will be one of the most important items for future developments and it is also an item about which much is published. The major issue is that there is a wide variance in the literature, so default values can be improved as we get increasing access to measured test data.
- Adding vans (Light Commercial Vehicles) as this is an important vehicle category for policymakers in cities and logistics companies.
- Adding other additional “alternative fuels” like natural gas, synthetic fuels and biofuels as options to impact the GHG life cycle emissions.
- An “energy” module and other modules like air quality (NO_x, PMs) can be developed and added.

11. References

Arena, M. Azzone, G. Conte, A. (2013) A streamlined LCA framework to support early decision making in vehicle development. *Journal of Cleaner Production*, Volume 41, 2013, Pages 105-113, ISSN 0959-6526, <https://doi.org/10.1016/j.jclepro.2012.09.031>

Danilecki, K. Mrozik, M. Smurawski, A. (2017) Changes in the environmental profile of a popular passenger car over the last 30 years – Results of a simplified LCA study. *Journal of Cleaner Production*, Volume 141, 2017, Pages 208-218, ISSN 0959-6526, <https://doi.org/10.1016/j.jclepro.2016.09.050>.

Del Duce, A. et al., 2013: Guidelines for the LCA of electric vehicles, E-mobility Life Cycle Assessment Recommendations (eLCAR) deliverable 2.1.

Dittrich M. and J. Sliggers, 2014, A Policy Indicator for Road Traffic Noise Emission, Informal document GRB-62-14 (62nd GRB, 1-3 September 2015, agenda items 7 and 9), see <http://www.unece.org/fileadmin/DAM/trans/doc/2015/wp29grb/GRB-62-14-Add.1.pdf> (presentation) and <http://www.unece.org/fileadmin/DAM/trans/doc/2015/wp29grb/GRB-62-14e.pdf> (paper)

Dunn, J.; Burnham, A.; Wang, J; Elgowainy. A; Jungmeier, G; Gaines, L (2013) A Step-by-Step Examination of Electric Vehicle Life Cycle Analysis. LCA XIII Orlando, Florida October 1, 2013

Edwards, R. et al., 2014: Well-to-Tank Report Version 4.a, JEC Well-to-Wheels Analysis, Joint Research Centre – Institute for Energy and Transport.

Edwards, R. et al., 2014: Well-to-Wheels Report Version 4.a, JEC Well-to-Wheels Analysis, Joint Research Centre – Institute for Energy and Transport.

Feigenbaum, E. et al., 2016: Learning from Norwegian Battery Electric and Plug-in Electric Vehicle Users.

Hawkins, T., B. Singh, G. Majeau-Bettez and A. H. Stromman, 2013: Comparative Environmental Life Cycle Assessment of Conventional and Electric Vehicles, *Journal of Industrial Ecology*, 2013.

JRC (2014) Well-to-Wheels analysis of future automotive fuels and powertrains in the European context, Appendix 1, Version 4a, April 2014.

Kim, H. C. et al. (2016): Cradle-to-Gate Emissions from a Commercial Electric Vehicle Li-Ion Battery: A Comparative Analysis. *Environmental Science & Technology* 50(14), 7715–7722.

Korzhenevych, A. et al., (2014): Update of the Handbook on External Costs of Transport, Final report, Ricardo-AEA ref. ED 57769, commissioned by European Commission – DG Mobility and Transport.

Ligterink, N.E.; Smokers, R.T.M.; Spreen, J.; Mock, P.; Tietge, U. (2016) Supporting analysis on real-world light-duty vehicle CO₂ emissions, DG CLIMA FW CO₂ LD: SR6 Analysis Real World, TNO & ICCT, September 2016.

Ligterink, N.; Smokers, R. (2014) Monitoring van plug-in hybride voertuigen (PHEVs) april 2012 t/m maart 2016, TNO-2016-R1093

Nordelöf, A; Messagie, M.; Tillman, Anne-Marie; Ljunggren Söderman, M.; Van Mierlo, J. (2014) Environmental impacts of hybrid, plug-in hybrid, and battery electric vehicles—what can we learn from life cycle assessment? *Int J Life Cycle Assess* (2014) 19:1866–1890 DOI 10.1007/s11367-014-0788-0

Peters, J; Baumann, M; Zimmermann, B.; Braun, J.; Weil, M. (2016) The environmental impact of Li-Ion batteries and the role of key parameters – A review. *Renewable and Sustainable Energy Reviews* 67 (2017) 491–506

Qiao, Q. Zhao, F. Zongwei, L. Jiang, S. Hao, H. (2017) Comparative Study on Life Cycle CO₂ Emissions from the Production of Electric and Conventional Vehicles in China, *Energy Procedia*, Volume 105, 2017, Pages 3584-3595, ISSN 1876-6102, <https://doi.org/10.1016/j.egypro.2017.03.827>.

Sharpe, B. and R. Muncrief, 2015: Literature review: real-world fuel consumption of heavy-duty vehicles in the United States, China, and the European Union, ICCT White paper, January 2015.

Verbeek, R., M. Bolech, R. van Gijlswijk and J. Spreen, 2015: Energie- en milieu-aspecten van elektrische personenvoertuigen, TNO report R10386.

Wang, M.; Elgowainy, A.; Han, J. (2014) Emissions Modeling: GREET Life Cycle Analysis. The 2014 DOE Vehicle Technologies Office Annual Merit Review and Peer Evaluation Meeting. Argonne National Laboratory, April 2014.

Zackrisson, M; Avellán, L; Orlenius, J. (2010) Life cycle assessment of lithium-ion batteries for plug-in hybrid electric vehicles e Critical issues. Journal of Cleaner Production 18 (2010)

12. Annex 1: Methodological Framework using LCA

Introduction to Life Cycle Assessment

Environmental Life Cycle Assessment (LCA) is a framework for evaluation of the environmental impact of a product or service over its entire life (Principles and framework ISO Standard 14040:2006; Requirements and guidelines ISO 14044:2006). It can be used to identify hotspots in environmental impact associated to a product. Potential improvement options can be screened for unwanted transfer of environmental impact to other parts of the life cycle, other locations or next generations.

Environmental impact can be defined as an adverse effect of human activities on the environment, due to extraction of materials from the environment, such as happens in mining, or release of foreign substances to the environment, such as emissions to air, water and soil.

The subject of an LCA is typically a function, not a product. It is described in the *functional unit*. This may be 'providing personal transport over a distance of 200.000 km'. In this example, a vehicle with combustion engine as well as an electric vehicle can fulfil the function. To that end, it needs to be produced, maintained and decommissioned. The desired function must be defined carefully to make fair comparisons. If an electric vehicle had a life span of 400.000 km, only ½ vehicle would be needed for this function. In that case, it is sensible to include the distance in the functional unit.

Key in an LCA is setting the scope and boundaries of the assessment right, to be sure to include all processes that contribute to the environmental burden of the product. For instance, when looking at the life cycle of a vehicle, the production of the fuel needs to be considered as well, since it is consumed during the useful life of the vehicle. In comparisons of products or services, at least all processes where a difference occurs should be included.

After setting the scope and boundaries, raw material use and emission data is inventoried for each of the processes in the life cycle, and translated to the functional unit. For instance, the emissions from a vehicle assembly plant are divided by the number of vehicles produced per year. Next, these raw materials and emissions are translated into environmental impact. The emissions of CO₂, methane and some other greenhouse gases are translated into their contribution to global warming by multiplying the amount by the respective global warming potential for each substance. The same can be done to translate emissions of nitrogen oxides and volatile organic compounds into the contribution to summer smog. This way, by adding the results up, one can calculate the contribution to global warming and summer smog (and other impact categories) of one functional unit of product or service.

As a last step, the results are interpreted. Contributions of individual life phases and individual processes can be identified. Also, by changing some key parameters, for instance the life span of a vehicle in km, the sensitivity of the results to these parameters can be evaluated. In some cases, the preferable option in a comparison changes, in other words:

the outcome is not robust to changes of the parameter tested. This is important additional information for the reader.

Carbon footprint

An LCA should cover a full spectrum of environmental issues, ranging from resource depletion to aquatic toxicity. Due to time constraints, the present work is focused on one single issue: climate change. Therefore, it is more accurate to speak of a Carbon Footprint. The life cycle scope remains intact, but the effects on other environmental impact categories are not assessed.

General methodological choices in the model

The model behind this study is a carbon footprint model. In principle, an endless variety of results can be generated with the model, although checks on the validity of the input and the interpretation of the results must be done by the user of the model. Results in validated form are presented in this document.

Functional unit

The functional unit chosen is:

Providing personal transportation* over a distance of 1 km
--

*) protected against weather influences and against crashes, with a minimum vehicle design speed of 100 km/h; the functional unit considers 1 person (the model does allow to add extra weight to simulate additional persons)

Scope

The abovementioned functional unit can be fulfilled by the following passenger car options that form the scope of the carbon footprint model:

- ICEV petrol
- ICEV diesel
- PHEV petrol/electricity
- PHEV diesel/electricity
- BEV

Fuels other than petrol and diesel have not been considered.

The size and level of luxury has an influence on the environmental impact. To incorporate this, four chassis types have been included:

- Compact (city car)
- Standard (compact family car)
- Luxury (large saloon type car)
- SUV

The differences are reflected in the material composition of each vehicle. This, as well as the weight of the empty vehicle, helps to predict the environmental impact of production and decommissioning of the vehicle.

System boundaries

Within the system boundaries is the entire vehicle chain as well as the entire energy carrier chain (fuel/electricity). This is depicted in figure A1.1.

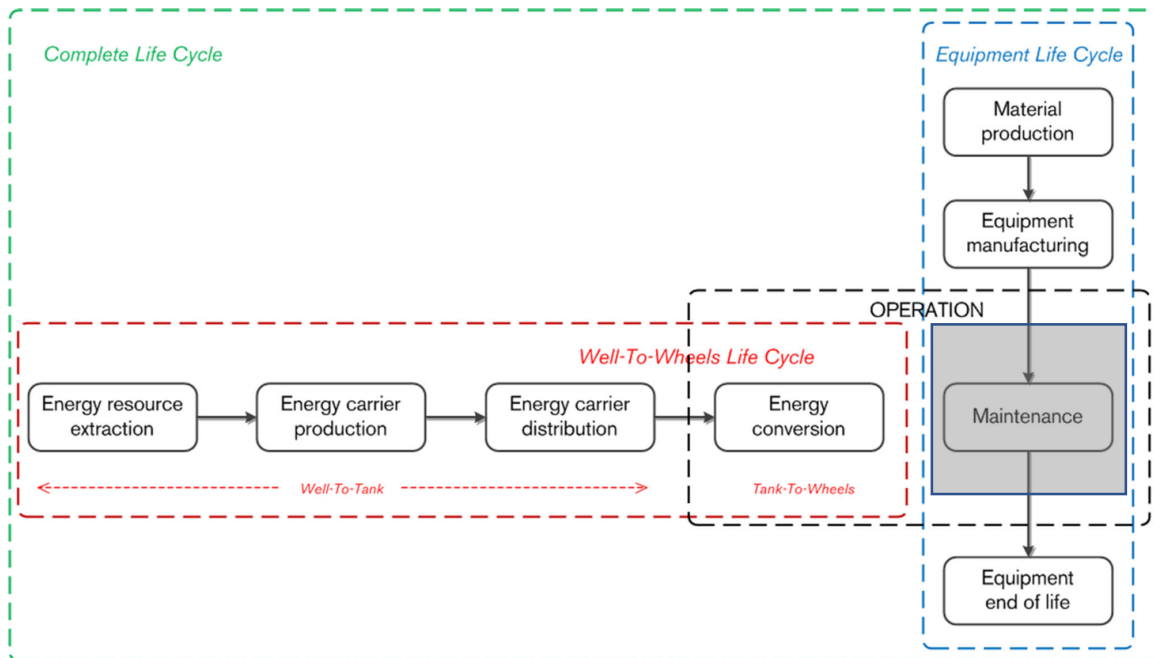

Figure A1.1 System boundaries of the model (greyed out area is outside the boundaries)

The energy carrier chain is sometimes referred to as the Well-To-Wheels life cycle. The production chain of the fuel or electricity is called Well-To-Tank, the conversion in the vehicle to power at the wheels is called Tank-To-Wheel.

The vehicle chain, shown on the vertical axis in the diagram, encompasses the production of raw materials such as steel, rubber and lithium, the production of sub-assemblies such as an engine or a battery, the assembly of the vehicle, operation of the vehicle, dismantling of the vehicle and recycling or reuse of the materials.

Maintenance is excluded from the boundaries. The contribution to the results for a standard vehicle is expected to be approximately 3%.

The energy consumed for the distribution of fuels and electricity is considered.

Impact assessment method

The carbon footprint is calculated by multiplying the emission of greenhouse gases with their respective global warming potentials (GWPs). A GWP is a measure for the contribution to trapping heat in the atmosphere, with carbon dioxide as the standard (GWP=1). The GWP is dependent on the effect (radiation absorption) and the lifetime of the gas in the atmosphere. For each greenhouse gas the lifetime in the atmosphere is different, so the effect relative to CO₂ changes dependent on the time frame considered. Usually 100 years is

assumed (GWP₁₀₀). The GWP₁₀₀s for this study have been derived from the IPCC Activity Report 5, which was published in 2013¹.

The GWPs are listed in Table 1.

Table 1 Global warming potentials [IPCC AR5, 2013]

Common name	Chemical formula	GWP ₁₀₀
Carbon dioxide	CO ₂	1
Methane	CH ₄	28
Nitrous oxide	N ₂ O	265
CFC-11	CCl ₃ F	4,660
CFC-12	CCl ₂ F ₂	10,200
R134a	CH ₂ FCF ₃	1,300
R152a (HFC152a)	CH ₃ CHF ₂	138
Sulfur hexafluoride	SF ₆	23,500

As CO₂ is the reference, the contribution of a product life cycle to the greenhouse effect is expressed as kg CO₂ equivalents.

Structure of the model

The model consists of a main part and 7 life phase specific modules. The life cycle calculations in the model are arranged in such a way that each module can pass parameters to the other parts through the control panel. For instance, the vehicle mass, engine power and drive cycle are fed into the use model, which returns its fuel consumption to the main model. The fuel production model is passed on the fuel consumption to calculate the CO₂ emission.

The structure is illustrated in Figure .

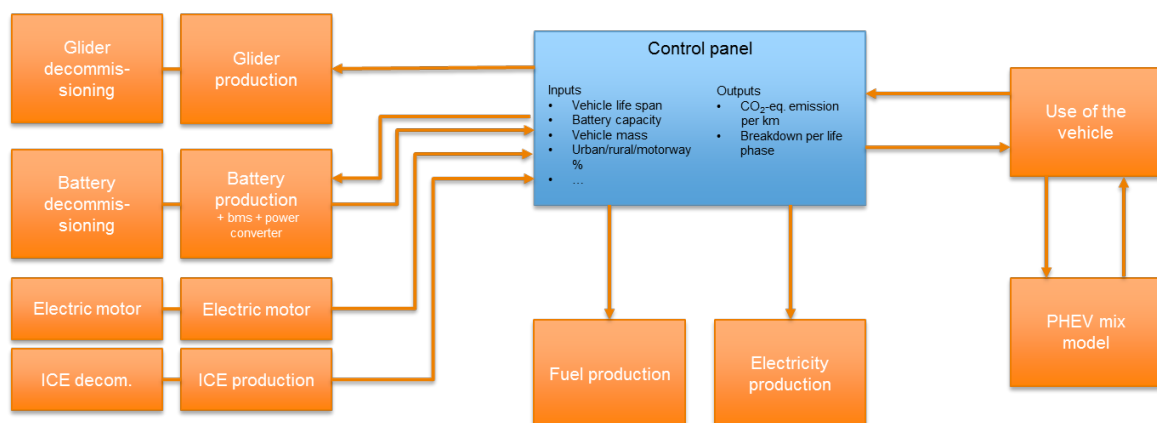

Figure 17 : Model structure

The functionality and data sources of each of the model parts is explained in annex 2.

¹ IPCC, 2013, *Climate Change 2013: The Physical Science Basis. Contribution of Working Group I to the Fifth Assessment Report of the Intergovernmental Panel on Climate Change, Ch.8, p. 711-714, Table 8.7. 2013.*

13. Annex 2 - Calculation Methodology

As described in Annex 1, the lifecycle CO₂ calculation is decomposed into several coupled modules that take parameters from the control panel and calculate a solution.

Control Variables and Dependencies

The control variables are user-settable parameters affecting calculations in one of the submodules. The listing of user parameters and their use in the calculation is as follows. In addition, there is a long list of further 'data' variables that is also accessible and able to be updated as better results are available.

<i>Parameter</i>	<i>Example input</i>	<i>Has effect on CO₂ emission of</i>
<i>Vehicle life in km</i>	200000, 300000	Vehicle production and decommissioning (more km = less production impact per km)
<i>Vehicle class / chassis composition</i>	Standard, compact, SUV, luxury	Vehicle production and recycling impact through material composition
<i>Vehicle drivetrain type</i>	Petrol, diesel, PHEV, BEV	Fuel / electricity production, energy consumption, tailpipe emissions
<i>Battery chemistry</i>	LFP, LCO, LMO, NCM, NCA,	Battery production impact and recyclability
<i>Battery capacity in kWh</i>	32	Battery production impact, %km electric for PHEV
<i>Battery mass in kg</i>	300	Is automatically calculated from capacity and chemistry. The result can be manually overridden.
<i>Battery recycling method</i>	None, pyro metallurgical, hydrometallurgical	CO ₂ credits of recycling after use
<i>Vehicle mass in kg</i>	1250	Vehicle production and recycling impact, energy consumption
<i>Driver/passengers/luggage</i>	75	Energy consumption
<i>Engine power / electric motor power</i>	100	Engine losses (energy consumption), engine/motor production and recycling
<i>Electricity mix</i>	EU 28 mix, France, wind	Electricity production
<i>Electricity mix for battery production</i>	EU 28 mix, France, wind	Vehicle production
<i>Electricity mix for chassis production</i>	EU 28 mix, France, wind	Vehicle production
<i>Driving cycle</i>	NEDC, CADC, custom	Energy consumption
<i>Urban/rural/motorway %</i>	20%/25%/55%	Energy consumption

Modules

The modules are shown in Figure 18. The text next to the lines indicates the information flow to and from the control panel.

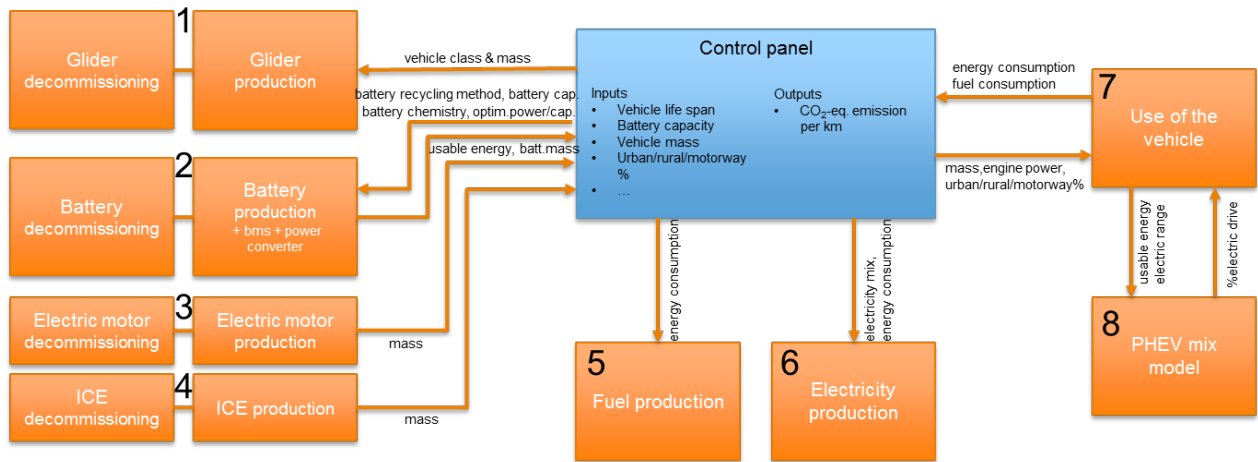

Figure 18 : Model structure and data exchange

As can be seen in the diagram, some modules produce outputs that serve as inputs to other modules. By design, the model has been set up to be modular, but there is a need to propagate calculated values that decides the order of calculation. The submodules numbered 1...8 are described below.

1. Glider production and decommissioning

The design goal of the glider module is to produce a CO₂ estimate for the glider (i.e. chassis + powertrain + body + tires) that is accurate to within 10% versus literature studies given simple parameters. Because the chassis typically accounts for 15-25% of the lifecycle CO₂ emission for petroleum vehicles [e.g. Quao et al 2017; Danileki et al, 2017; Wang et al. 2014; Arena et al, 2013; etc.], this goal is adequate to keep error at the vehicle lifecycle level to under 2.5% from the glider module. The composition of the vehicle becomes relatively more important for electric vehicles, particularly under future renewable energy scenarios, but does not qualitatively affect the results presented here and based in present day data.

Considering only the glider, it is well established that the clear majority of the emissions come from the provision and shaping of the raw materials, with further marginal amounts coming from energy use during processes such as assembly and painting the vehicle [e.g. Wang et al 2014]. Thus, the chosen model form is to calculate a material breakdown and add a small specific energy use to represent shaping each material (stamping, milling etc.). Virgin material lifecycle data is used to assign CO₂ emissions for each material, with recovery credits estimated by a simple calculation of the material specific recovery rate by a credit that is calculated from the difference between virgin material and the global average.

Energy use during manufacturing is assigned emissions based on the chosen electricity grid. This is a highly simplified procedure from an LCA perspective, but is quite capable of producing cradle-to-gate estimates within the design tolerance vis-a-vis LCA literature and manufacturer's own studies. Later in the section, sources of error and sensitive assumptions will be discussed.

Calculation procedure

First, the mass of the ICE and electric motors are estimated from a linear trend based on an assumed specific engine power (kW/kg) coefficient. These masses inform the specific composition calculation for those components. Second, the mass of the battery is calculated. A certain mass is assigned to tires (rubber), electronics and cabling, and the remaining mass is then assigned a composition based on the selected body type as follows.

Chassis Type	Steel	Aluminium	Plastic	Glass
<i>Standard</i>	71%	10%	15%	4%
<i>SUV</i>	71%	10%	15%	4%
<i>Lightweight/Sport</i>	61%	20%	15%	4%
<i>Compact</i>	71%	10%	15%	4%
<i>Luxury</i>	61%	20%	15%	4%

The above mass compositions are loosely based on manufacturer's brochures and observed teardowns of vehicles and are representative of most cars placed on the road today. The model allows for specific composition overrides, e.g. if the exact composition of a body type is known it can be entered. In the future, other materials may become more widespread (e.g. carbon fibre, magnesium), but at present they are only used sparingly and in very small percentage of the fleet.

Summing the material breakdown of each component in the vehicle, one arrives at a material bill. This bill then has a manufacturing energy assigned to it, using the specified electricity source, and all materials are multiplied by the specific emission factor designated in the Ecolnvent database.

Recycling and decommissioning

Recycling is accounted for through a simple multiplication of two factors, the 'recovery factor', e.g. what percentage of that material is recovered by recycling processes, and a carbon credit. The carbon credit is calculated by taking the difference between virgin material and the Europe wide average recycling unit process. The battery is handled differently with a specialized model.

Material Data	Emission Factor [kgCO₂/kg]	Recovery Factor [%]	CO₂ Credit [%]	References/ Notes
<i>Steel (hot rolled)</i>	0.986	0.8	0.6	Recovery factors estimated by experiment, cf. Realize project.
<i>Aluminium (stamped)</i>	12.262	0.7	0.85	
<i>Copper</i>	3.37	0.3	0.7	CO ₂ credit assessed as difference between virgin material and recycled material at market.
<i>Plastic (HDPE)</i>	2.62	0.6	0.5	
<i>Glass (safety, glazed)</i>	5.5	0.8	0.3	
<i>Rubber (synthetic)</i>	3.51	1.0	0.4	
<i>Electronics</i>	26.8	0.3	0.2	

<i>Magnet (based on neodymium oxide)</i>	32.41	0.0	0.8
--	-------	-----	-----

Data Confidence and Sensitivity

While every parameter affects the result, many have low sensitivity and high data confidence, and are thus not relevant for discussion. The key parameters affecting sensitivity for the glider result are shown in the table below.

<i>Parameter</i>	<i>Value (unit)</i>	<i>Sensitivity Factor (% glider/% change)</i>	<i>Sensitivity Factor (% lifecycle/% change)</i>	<i>Data Confidence</i>	<i>Notes</i>
<i>Aluminium recycling parameters</i>	0.7/0.85	0.1	0.007	Moderate/High	CO2 credit well studied, but Al recovery rate varies by recycling facility.
<i>Aluminium Composition</i>	Varies %	0.08	0.000	Moderate.	Function of car class. Can be overridden for direct comparability with other studies
<i>Glass recycling parameters</i>	0.8/0.3	0.04	0.000	High, Moderate	Glass recovery rate known empirically, but credit difficult to calculate
<i>Steel recycling parameters</i>	0.8/0.6	0.03	0.000	High, High	Both well supported by data
ESTIMATED UNCERTAINTY CONTRIBUTION	Glider	+/- 7%	Vehicle lifecycle	+/- 2%	Using 5% variance for high confidence, 15% for moderate.

The most sensitive parameters are unsurprisingly the assumptions surrounding recycling of the biggest (steel) and most emission intensive (aluminium) components. Given that these values are relatively well studied in literature, the resulting uncertainty is not extreme. If one assigns high confidence data a 5% variance, and moderate confidence data 15%, the linear estimate for uncertainty arising from the four largest parameters is approximately 7% for the glider lifecycle and 2% for the overall lifecycle. These assumptions would have to be made in any LCA and validate the simplified procedure; detailed accounts of cabling, or other alloys have very small comparative impact.

2. Battery production and decommissioning

The battery is known to be a significant contributor to the production lifecycle of BEVs, PHEVs, and, to a lesser extent, hybrids [Nordelöf et al 2015, Dunn et al, 2013]. In addition, as background electricity for the use phase becomes greener, the battery will take on increasing importance. The design purpose of the battery model presented here is to have a fully parameterized model which can be adjusted to match either the known specifications of a manufacturer or alternatively the key variables of literature studies. This flexibility is necessary because of the extremely large variance in literature results.

The reason that this is possible to do is that the background supply systems for most battery materials are reasonably well known and global supply chains at present, and the material input is a large part of the final CO₂ bill. The other major component of the CO₂ total is a manufacturing energy that is associated with the assembly of the battery, and is much less well understood [Peters et al. 2016]. The model allows selection of this value, as well as assigning a relevant electricity system to it in order to simulate any study scope.

The model operates in three steps:

First, the material quantities for the cell are calculated from the specified energy density for the chemistry, and the desired final capacity of the battery. Default values for the energy density are taken from Peters et al., 2016, but are fully settable in the model. Of note, *the energy density has also a very high variance in literature, and has a large effect on the final value*. The default values are higher than most historical literature, more or less in line with current measurements, and are expected to be low in just a few years. This means that with default settings the model will produce battery CO₂ totals that are lower than most literature values. Later in this section, we show that we can replicate literature studies by selecting the parameters that they used. The cell material CO₂ bill is then based on summing results calculated for the input cell materials.

Second, a manufacturing energy is assigned to the manufacturing process, again with a settable electricity subsystem. The default values come from one subset of bottom up approaches in the literature, but it is worth noting that at least one ‘top down’ approach [Ellingson 2014] produces a much higher estimate for this value. Using this as an alternative default is a checkbox on the control panel.

Finally, the CO₂ contribution for the casings and busbars, etc. are calculated by scaling a default material composition up with the volume of the battery. Thus large batteries are marginally more efficient than smaller, but this is a small effect compared to manufacturing and cell materials. The CO₂ contribution from the casing, cabling and electronics is done by the same simplified approach used in glider production, assuming the recovery rate (not the recycling rate) is 100% in the event that the battery is recycled. The assumptions for the materials in the module and pack casings are as follows:

Pack: 86% (Variable) module at 23kWh, 8% steel, 5% copper, 1% electronics

Module: 90% cell, 9% steel, 1% copper

The ‘default’ values for energy density and the resulting carbon intensity of the cell materials are as show in the following table: Adjusting the energy density will change the carbon intensity of the cell materials as measured per kWh. Also shown are the full battery results with the default manufacturing process for two different electricity systems. Once again note that the full results using European energy are lower than most lifecycle literature and the main reason is the comparatively high energy density used as a default, and the increasingly clean electricity mix compared to historical studies. The values for energy density are in fact comparable (or even slightly low) for the most modern batteries of each type.

Cell Type	Energy Density (kWh/kg)	Carbon Intensity of cell materials (kgCO ₂ /kWh)	Full result (Europe elec mix for manuf.) (kgCO ₂ /kWh)	Full result (Coal elec for manuf.) (kgCO ₂ /kWh)
LFP	0.097	66	110	171
LCO	0.172	48	76	110
LMO	0.118	51	89	138
NCM	0.135	60	94	137
NCA	0.138	55	88	131
LFP-LTO	0.070	85	143	227

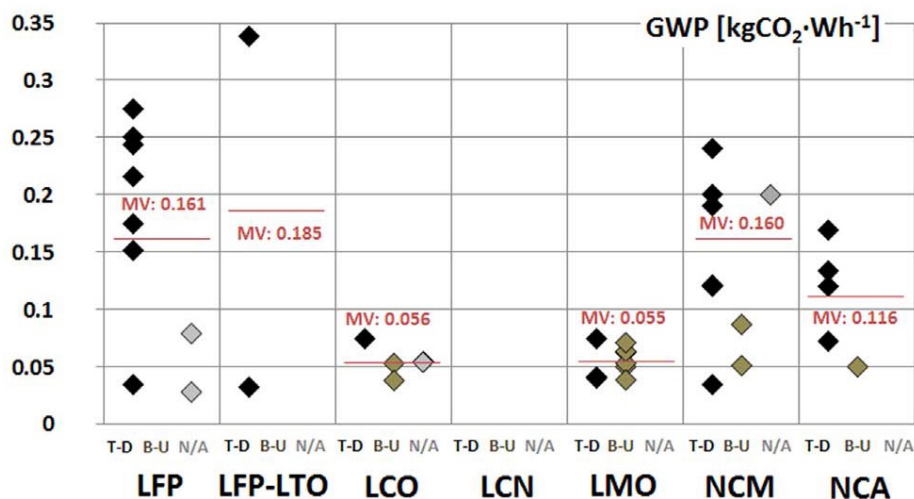

Figure 19: Literature results for cell carbon intensity (Peters et al 2016)

The results can be compared to the uncertainty shown by Peters et. al (2016) above, but can also be tested against other LCAs with reasonable fidelity as shown in the table below. This demonstrates how the model can be configured to reasonable agreement with literature values through the extensive parameterization ability. This also demonstrates the general soundness of the calculation.

Literature Study	Parameter settings based on study	Literature Result (kgCO ₂ /kWh)	Model Result (kgCO ₂ /kWh)
Kim et al (2016)	NCM, 24kWh, South Korea manufacturing electricity, 127 Wh/kg energy density	140	142
Zackrisson et al. (2010)	LFP, 10 kWh, Europe electricity 2010 mix, 93 Wh/kg (full battery), 11 kWh electricity and 8 kWh NG manufacturing, graphite instead of MCMB for anode, 4.6kg total electronics	165	160

Recycling and decommissioning

Recycling is accounted for by assigning a CO2 credit for materials depending on the recycling process chosen. These values are derived using Ecoinvent data for the returned chemical and proprietary process data and literature and private descriptions of the process. The credits thus include the material recovery factor. This approach implicitly assumes all batteries will be collected; no recycling is however a model settable option and is the default.

Cell Type	Recovery credit pyro metallurgical	Recovery credit hydrometallurgical
<i>LFP</i>	0.09	0.47
<i>LCO</i>	0.19	0.46
<i>LMO</i>	0.08	0.49
<i>NCM</i>	0.175	0.49
<i>NCA</i>	0.16	0.4
<i>LFP-LTO</i>	0.16	0.4

Data Confidence and Sensitivity

All parameters about the battery chemistry affect the result. While care has been taken to select the best *current* literature and measured values for CO2 intensity and energy density, the literature shows a wide variance in these values because of history, scope, and data used. The recycling factors are based off a highly detailed module, but also vary depending on the CO2 intensity of the input materials. We thus rate the input parameters of both CO2 intensity and energy density as moderate-low confidence, with a probable variance on the order of 20% or more. Also, as seen from the table above figure 19, the choice of manufacturing electricity system is also decisive.

Of these two factors, energy density is the most sensitive, as it affects the mass of the vehicle, and hence the energy required to drive it. Over the lifecycle, this effect can be as important as the CO2 of the cell materials in the first place.

Without recycling assumed, the battery accounts for 5-10% of the vehicle lifecycle, depending on other parameters. A 20% variance in these factors translates into about a 2-4% variance on the final lifecycle figure.

In addition, the choice of electricity system can change the result by a further 50% up or 30% down, relative to the European 2017 electricity mix, potentially adding another 5% variance on the full vehicle lifecycle, but this is not an uncertainty as for the other parameters. As we showed, using the correct choice allows replicating literature results but needs to be made explicit when doing any sort of comparison.

3. Electric motor production and decommissioning

Electric motors were assumed to be composed of steel, copper, and neodymium magnet material. The total mass was based upon a linear regression of OEM parts versus their rated power, and the composition was adapted from an average of several tear-downs of commercial motors. The observed relation was 1.3 kW output / kg mass with the motor composition set at 87% steel, 10% drawn copper wire, and 3% neodymium magnet.

4. Internal combustion engine production and decommissioning

The internal combustion engine is assumed to be entirely constructed of cast aluminium, with a mass based on a regression versus engine power for observed production models. The observed relation was 0.65 kW output / kg mass.

5. Fuel production

Fuel production for petrol and diesel was sourced from the cumulative impact assessment data in EcoInvent 3.3, taken as the average of the European fuel chain, and accounting for all transformations and transport. The data is comparable to and derived from the same sources used in JRC 2014. The values used are as follows:

<i>Fuel</i>	<i>2016 Value</i>	<i>Unit</i>	<i>Reference Data</i>
<i>Petrol</i>	0.0157	kg CO2/MJ	ECOINVENT 3.3 LCIA, IPCC2013 GWP100
<i>Diesel</i>	0.01123	kg CO2/MJ	ECOINVENT 3.3 LCIA, IPCC2013 GWP100

Future iterations of the model could possibly include regional variations, or time based development of the fuel chain.

6. Electricity production

An option is given to assign a different electricity production system to the use, battery production, and chassis production phases of the vehicle. For each lifecycle process, the data can be drawn from a selection of values calculated for many countries and aggregate regions (2016 data). For comparison, the most commonly used emission factors are as follows:

<i>Electricity</i>	<i>kgCO2/kWh</i>
<i>EU 28 mix</i>	0.337
<i>coal</i>	0.924
<i>natural gas</i>	0.409
<i>wind</i>	0.011

<i>solar</i>	0.107
<i>World</i>	0.528
<i>OECD Americas</i>	0.450
<i>OECD Asia Oceania</i>	0.585
<i>OECD Europe</i>	0.322

7. Use of the vehicle

The use model estimates the CO₂ emission of the vehicle at the tailpipe per km. For electric vehicles, it calculates the electricity demand at the charger per driven km.

The model is based upon the work done in [Ligterink, 2016]. It was intended for ICE passenger cars, and has been adapted for the estimation of EV energy consumption specifically for this Task.

Starting from the maximum possible conversion efficiency of a passenger car ICE, one can calculate what the CO₂ emission would be per kWh of work generated in the engine. For a diesel passenger car, this would be approximately 680 g CO₂/kWh, for gasoline approximately 740 g CO₂/kWh (Ligterink mentions a typical value of 720 g/kWh and considers the variation between petrol and diesel too small to distinguish). With a typical 250 N force of driving resistance this would equal about 47 g CO₂/km for constant speed driving; this is the absolute minimum required for propelling a normal passenger car with conventional engine technology at constant speed, based on physical principles.

These ideal conditions are scarce. Usually the speed is not constant, the engine is not at its most efficient speed and torque level, air drag increases substantially with speed, losses are created by braking, and air conditioning and passengers add to the engine work per km.

The amount of energy required or lost by each of these factors can be quantified, to adjust upwards the CO₂ emission per km. This leads to realistic values for vehicles with conventional 2017 technology.

During test cycles, such as NEDC, WLTP and CADC, flexibilities are utilised as observed in road load differences, minimised auxiliary power usage and reduced weight (NEDC only).

These three are included in the model predictions for the respective cycles. Other flexibilities and 'fit-for-purpose' adjustments have not been included.

The basis for the upward adjustment of the CO₂ emission per km is based on the following approximations:

- A difference in energy of 1 MJ leads to a difference in emission of ~ 200 g CO₂
- A difference of 1 N of force equals 1 kJ/km, which equals ~ 0.2 g CO₂/km
- A difference in weight of 100 kg equals ~ Δ 10 N resistance (~2 g CO₂/km)
- A difference of 100 W auxiliary load ~ 0.02 g/s CO₂ ~ 3 g/km urban and 0.7 g/km motorway. Auxiliary load average ~ 300 W.
- Brake to standstill ~ 0.05 * v² kJ = 0.01 v² g CO₂ ~ 25 g (from 50 km/h) and 100 g (100 km/h)
- Engine losses (modern, low load) ~ 3% of rated power: 0.006 g/s per kW
 - o In case of 80 kW rated power, urban ~ 70 g/km, motorway ~ 17 g/km
 - o Idling 10% of the time contributes 10% to urban losses
- Air drag force ~ 0.04 * v² [N] ~ 320 N at 100 km/h ~ 80 g/km

- Auxiliary losses are inversely proportional to the average velocity
- A cold start increases CO₂ emissions by 100 grams. Assuming an average trip duration of 45 minutes and an average speed of 35 km/h this equals ~ 3.7 g/km

Note that the model does not have the details of a specific vehicle model. It must be a method of classifying effects and disentangling generic fuel consumption for different vehicle usage patterns and technologies.

As an example, a breakdown is shown for a 1250 kg car with 100 kW petrol engine for the NEDC cycle as well as a real driving example with 20% city driving, 25% rural driving and 55% highway; see Figure .

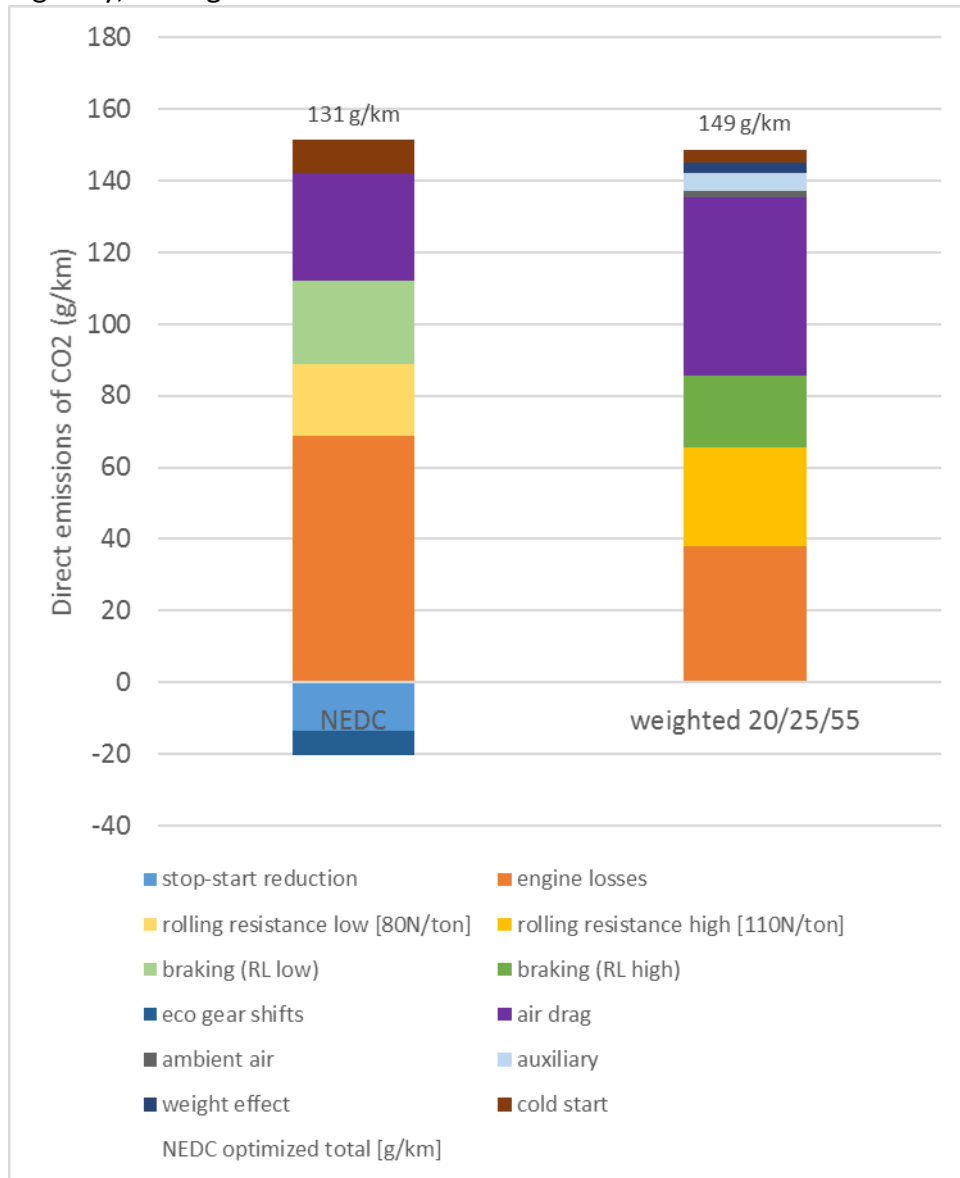

Figure 20 Example CO₂ emission breakdown for a 1250 kg 100 kW petrol car

Because not all NEDC flexibilities have been accounted for, the value for NEDC should be slightly overestimated.

The values of 131 g/km and 149 g/km can subsequently be translated into litres of petrol using an emission factor of 2.36 kg CO₂/litre of petrol (5.7 and 6.5 litre per 100 km, respectively). For diesel, the emission factor is 2.63 kg CO₂/litre [JRC, 2014].

The model described above calculates the CO₂ emission of combustion engine vehicles directly. The electricity consumption of an electric vehicle is determined partially by the same factors (air drag, rolling resistance, auxiliaries). The following adaptations were made to be able to use the model to predict the electricity consumption of an EV at the charger:

- All the above loss factors can be converted (back) to energy consumption per km by using the rule that 1 N of force equals 1 kJ/km equals ~ 0.2 g CO₂/km. In other words, every gram of CO₂ related to overcome these loss factors is assumed to equal 5 kJ/km.
- Brake energy recovery has been added. For NEDC/WLTP/CADC test conditions, 50% recovery was assumed (kJ/kJ). For real driving, with higher road load, the recovery rate is assumed to be 60%.
- Auxiliary load is increased by an estimated 200W on average for heating, resulting in 500W average auxiliary load. This translates directly into electricity consumption from the battery.
- Engine losses are not applicable
- Losses in the driveline are 5%
- Motor efficiency is 90% on average. Converter (power electronics) efficiency is 93%. These parameters have not been varied among the driving cycles.
- Battery charge/discharge cycle loss is 10%

8. PHEV mix model

A simple model has been used to estimate the share of kilometres driven on electricity and on gasoline/diesel for plug-in hybrid electric vehicles, given the battery capacity.

First, the electric energy consumption is calculated for EV mode, see the model description above. 50% of the battery charge/discharge losses were disregarded, to exclude charging losses. Next, the useable energy from the battery is set at 80% of the specified capacity. Deep discharging is usually avoided. With this information, the electric range is calculated. For an Audi A3 Sportback E-tron the calculated range is 53 km on NEDC. This is close to the specification of the manufacturer (50 km).

Based on PHEV monitoring in the Netherlands [Ligterink and Smokers, 2016], the relationship between the NEDC electric range and the percentage of kilometres driven electrically in the real world appears to be approximately linear, see Figure (left). The relation with the EPA range, which is much closer to the real driving range, shows somewhat more scatter but can still be considered linear, see Figure (right hand side).

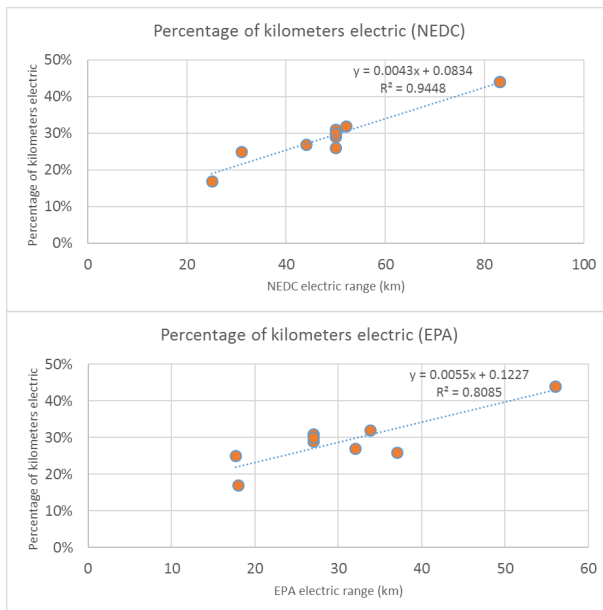

Figure 21 Percentage of kilometers driven electrically as a function of the electric range of a PHEV

For NEDC the following formula estimates the real world percentage of electric kilometers:

$$\text{Percentage electric km} = 0.0043 \times \text{NEDC electric range (km)} + 0.0834$$

For WLTP, CADC and real driving, the following formula estimates the real world percentage of electric kilometers:

$$\text{Percentage electric km} = 0.0055 \times \text{electric range}^* \text{ (km)} + 0.1227$$

*) range in WLTP or CADC cycle, or real driving range

For a given vehicle, both formulas should result in approximately the same percentage: the estimated real world percentage of kilometers driving.

For example, using the first formula an NEDC range of 50 km corresponds to 30% of electric driving. Using the vehicle model of the previous paragraph, it can be calculated that such a vehicle would have a range of ~34 km in case of 20/25/55% urban/rural/motorway driving. This corresponds, according to the second formula, to ~31% electric driving.

Please note that these values are averages and intended for model calculations. Besides the driving style and urban/rural/motorway ratio, the trip length distribution and frequency of charging have a large influence on the actual percentage of kilometres driven electrically.